

General Product Information

PRODUCT STANDARD / COMMENTS ON DEFINITIONS USED / CE MARKING / CONFORMITY TO COMPONENT STANDARDS / NATIONAL APPROVALS / PROTECTION

Product standard – equipment standard

The product standard only contains minimum requirements. Attention is drawn to the fact that appliance specifications might contain requirements additional to or deviating from those specified in the relevant product standards.

Comments on definitions used

Please be aware that the specifications nominal value used in the German part of the Schurter catalogue and the data sheets, is synonymous with rated value. The difference between these two values is a pure matter of definition. In order to avoid any unnecessary complications we will continue to use the specifications nominal value.

CE marking acc. to EU-directives

CE marking is the only marking which indicates that a product conforms to the relevant EU-directive.



This means that the CE-mark is no quality or standard conformity mark but only an administration mark. SCHURTER products are covered by the low voltage directives 2006/95/EEC. Those are valid for equipment and appliances with rated voltage values between AC 50 V to AC 1000 V as well as DC 75 V to DC 1500 V. The CE marking of SCHURTER parts will be found on the label of the smallest packing unit. On request we will submit a CE conformity statement for each component. CE conformity statements and approvals can also be retrieved from the internet under <http://www.schurter.com>.

Conformity to component standards, national approvals

National testing institutions are testing according to national and international standards or other generally recognized rules of technology. Their certification/approval-marks confirm the observance of the safety requirements which electric appliances must fulfil.

Conformity to component standards, national approvals

National testing institutions are testing according to national and international standards or other generally recognized rules of technology. Their certification/approval-marks confirm the observance of the safety requirements which electric appliances must fulfil.

		Electrical Certification
	VDE	Verband Deutscher Elektrotechniker
	VDE	Verband Deutscher Elektrotechniker
	UMF	
	UL	Underwriters' Laboratories (USA, Canada)
	UL	Underwriters' Laboratories (USA, Canada)
	UL	Underwriters' Laboratories (USA)
	UL	Underwriters' Laboratories (USA, Canada)
	CSA	Canadian Standard Association, Component Acceptance Service
	CSA	Canadian Standard Association
	CCC	Chinese Compulsory Certification
	CQC	Chinese Quality Certification (voluntary)
	PSE	Japan Electrical Safety & Environment technology Laboratories
	KTL	Korea Testing Laboratory
	TÜV	Technischer Überwachungsverein
	NF	Norme française
	NNO	Numéro de nomenclature Otan (OTAN = NATO = North Atlantic Treaty Organisation)
	GAM T1	Liste interarmées AIR MER TERRE de composants électroniques
	SEV	Schweizerischer Elektrotechnischer Verein
	SEMKO	Svenska Elektriska Materielkontrollanstalten
	FIMKO	Finnish Electrical Inspectorate
	KEMA	Keuring van Elektrotechnische Materialien
	IMQ	Instituto italiano del marchio di qualità

National approvals

In addition to the combined UL/CSA approvals, most of the SCHURTER components are also approved by one of the European

General Product Information

certification bodies like VDE (Germany), Electrosuisse (Switzerland) or SEMKO (Sweden). The safety testing of all these European certification bodies are based on the common European safety standards. With the harmonisation effort in Europe, the different national European certification bodies have lost their importance and SCHURTER has decided to maintain only one European approval (e.g. VDE, SEV or SEMKO) in future. The others will not be renewed once they have expired.

Because UL and CSA are not members of the CENELEC, the standards of UL and CSA are not harmonised yet with the European standards. However, UL and CSA are trying to harmonize their standards with each other. Where possible, SCHURTER will apply for the combined cULus or cURus approval.

Further to development in Asia, SCHURTER has obtained national approvals from China, Japan and Korea.

Information about approvals

SCHURTER products are certified according to EN / IEC standards and carry country specific approvals in Europe.

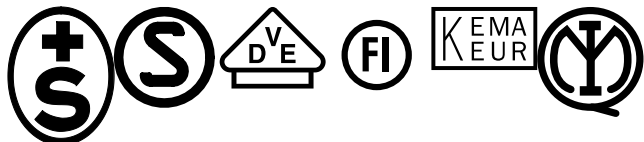

During the last few years European countries made much effort to reduce their approval marks to one generally accepted mark. The ENEC approval mark replaces (wherever possible) the previous approval mark. The ENEC mark is offered by all national certification bodies that signed for the European certification agreement (CCA)*.

SCHURTER decided to reduce the variety of European approval marks. For new approbations of SCHURTER parts only the ENEC will be mentioned in the future:



Approvals for the US and Canada are according to the UL and CSA standards:



As UL and CSA are not a member of CENELEC these two are not according to the European approval marks. Wherever possible SCHURTER want to acquire the combined cULus approval mark:



Since Aug. 1st. 2003 the Chinese approval mark is required for a lot of products to import to China. SCHURTER strives to get the approvals for the concerned products.

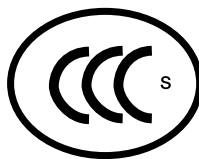

SCHURTER will check if a voluntary CQC registration can be done when a product does not apply with a Chinese standard.



Further information:
<http://www.enec.com>

Approval Industry Links

* members of ENEC agreement:

Reference	Key	Country
01	IMQ	Italy
02	KEMA	Netherlands
03	VDE	Germany
04	SEV	Switzerland
05	SEMKO	Sweden

IP DEGREES OF PROTECTION PROVIDED BY ENCLOSURES (IP CODE)

Standards IEC 60529; EN 60529 and DIN 40050

Scope

These standards apply to the classification of degrees of protection provided by enclosures for electrical equipment with a rated voltage not exceeding 72.5 kV.

Object

The object of these standards is to give:

a) Definitions for degrees of protection provided by enclosures of electrical equipment as regards:

1. Protection of persons against access to hazardous parts inside the enclosure
2. Protection of the equipment inside the enclosure against ingress of solid foreign objects
3. Protection of the equipment inside the enclosure against harmful effects due to the ingress of water.

b) Designations for these degrees of protection.

c) Requirements for each designation.

d) Tests to be performed to verify that the enclosure meets the requirements of these standards.

Designations

General Product Information

The degree of protection provided by an enclosure is indicated by the IP code.

Elements of the IP code and their meanings

A brief description of the IP code elements is given in the following table.

IP xy	Meaning for the protection of equipment	Meaning for the protection of persons
	Against ingress of solid foreign objectif	Against access to hazardous parts with
x = 0	(non protected)	(non protected)
x = 1	50 mm diameter	back of hand
x = 2	12.5 mm diameter	finger
x = 3	2.5 mm diameter	tool
x = 4	1.0 mm diameter	wire
x = 5	dust protected	wire
x = 6	dust tight	wire
	Against ingress of water with harmful effects	
y = 0	(non protected)	
y = 1	vertically dripping	
y = 2	dripping (15° tilted)	
y = 3	spraying	
y = 4	splashing	
y = 5	jetting	
y = 6	powerful jetting	
y = 7	temporary immersion	
y = 8	continuous immersion	
y = 9K	high pressure, i.e. steam jet cleaning	

PROTECTION AGAINST ELECTRIC SHOCK

1. Protection against direct and indirect contact – general terms

The protection against electric shock on electric equipment as well as their components are divided into the following parts:

- Protection against direct contact with live parts concerns all measures for the protection of human beings and animals against hazards which result from direct contact with live parts of electric equipment and their components.
- Protection against indirect contact is the protection of human beings and animals against hazards which result from contact of live parts¹⁾ of electric equipment as well as components thereof, which have become live due to an insulation failure.



¹⁾ Accessible, conductive part, which is not conductive normally but which may be conductive due to a failure.

2. Protection against direct contact with live parts e.g. of a fuseholder

The data sheets of the relevant components inform about the taken measures.

3. Protection against indirect contact

Measures for the protection against indirect contact on electrical equipment are defined according to IEC 61140 by the 4 protection classes 0, I, II, III. Each protection class includes two protection measures. Even if one of these measures should fail, no electric shocks will occur.

Protection class	Main protective measures
0	1. Basic insulation between live parts and accessible conductive parts. 2. Earth-free location, non-conducting environment.
I 	1. Basic insulation between live parts and accessible conductive parts. 2. Means are provided for the connection of accessible conductive parts of the equipment to the protective (earthing) conductor in the fixed wiring of the installation in such a way that accessible conductive parts cannot become live in the event of a failure of the basic insulation.
II 	1. Basic insulation between live parts and accessible conductive parts. 2. Additional insulation. Basic and supplementary insulation are summarised under the term "double insulation". Under certain circumstances also a "reinforced insulation" (single insulation system) may guarantee an equivalent protection against electric shock as a "double-insulation" does. No terminal for a protective conductor is allowable. A possibly existing protective conductor must not be connected and has to be insulated like any live part.
III 	1. Functional insulation. 2. Supply at safety extra-low voltage SELV (the circuit is isolated from the mains supply by such means as a safety isolating transformer). The protection against electric shock is in this case completely based on the supplying by SELV-circuits ($U \leq 42$ V). Higher voltages are not generated in the equipment. No terminal for a protective conductor is allowable.

General Product Information

IEC APPLIANCE COUPLERS

IEC connectors

Appliance couplers approved according IEC 60320 are designed as two pole appliance couplers for alternate current with or without protective conductor with a rated voltage of 250 V and a rated current of 16A for technical application that are desired for interconnection to flexible cords of electrical equipment for power supply of 50Hz or 60Hz.

Appliance couplers according mentioned standard are suitable for operation under environmental temperatures of normally 25° C and do not have to exceed 35° C.

Appliance couplers are designed for use without especial moisture protection. So the design of the appliance needs to assure ingress protection if it is designed to be used under these circumstances.

Following figures need to be respected in order to meet standard IEC 60320:

- Rated voltage: 250 VAC
- Rated current according type: 0.2A, 2.5A, 6A, 10A, 16A

The appliance couplers are separated according the maximum operation temperature at the base of the connector pin:

- Pin temperature up to 70°C: Appliance couplers for cold condition
- Pin temperature up to 120°C: Appliance couplers for warm condition

- Pin temperature up to 155°C: Appliance couplers for hot condition

Their outlines are coded in a way, that appliance couplers for hot conditions may also be used under cold conditions, and appliance couplers for very hot conditions may also be used under cold or hot conditions.

The appliance couplers are separated according the categories of equipment:

- Appliance couplers for appliances according protection class I
- Appliance couplers for appliances according protection class II
- The protection classes are described in standard IEC 61140

Appliance couplers will be additionally separated according the connection method to a flexible cord:

- Rewireable connectors
- Non-rewireable connectors

IEC appliance couplers

Appliance couplers, interconnection couplers and power plugs are developed and manufactured in accordance with national and international standards. These standards are issued in order to create a general consensus on the basic dimensions and safety goals of the appliance couplers. Following this approach, safety has been achieved, in the overwhelming majority of cases, when combining components. While the design of power plug systems is governed by the relevant national standards, appliance couplers follow the IEC 60320 standard, including its subsections.

The power supply of various electrical appliances follows country-specific requirements in terms of voltage and current. It is therefore practical for international appliance manufacturers to use IEC appliance couplers and interconnection couplers for their respective appliances' power supply. SCHURTER, i.e. its Gerätestecker http://www.schurter.ch/products/connectors_filters_overview.asp?Mating_Connectors strategic division, provides a wide range of products for such purposes. In order to ensure full compliance with the given standards, SCHURTER products are tested by independent testing organizations (See).

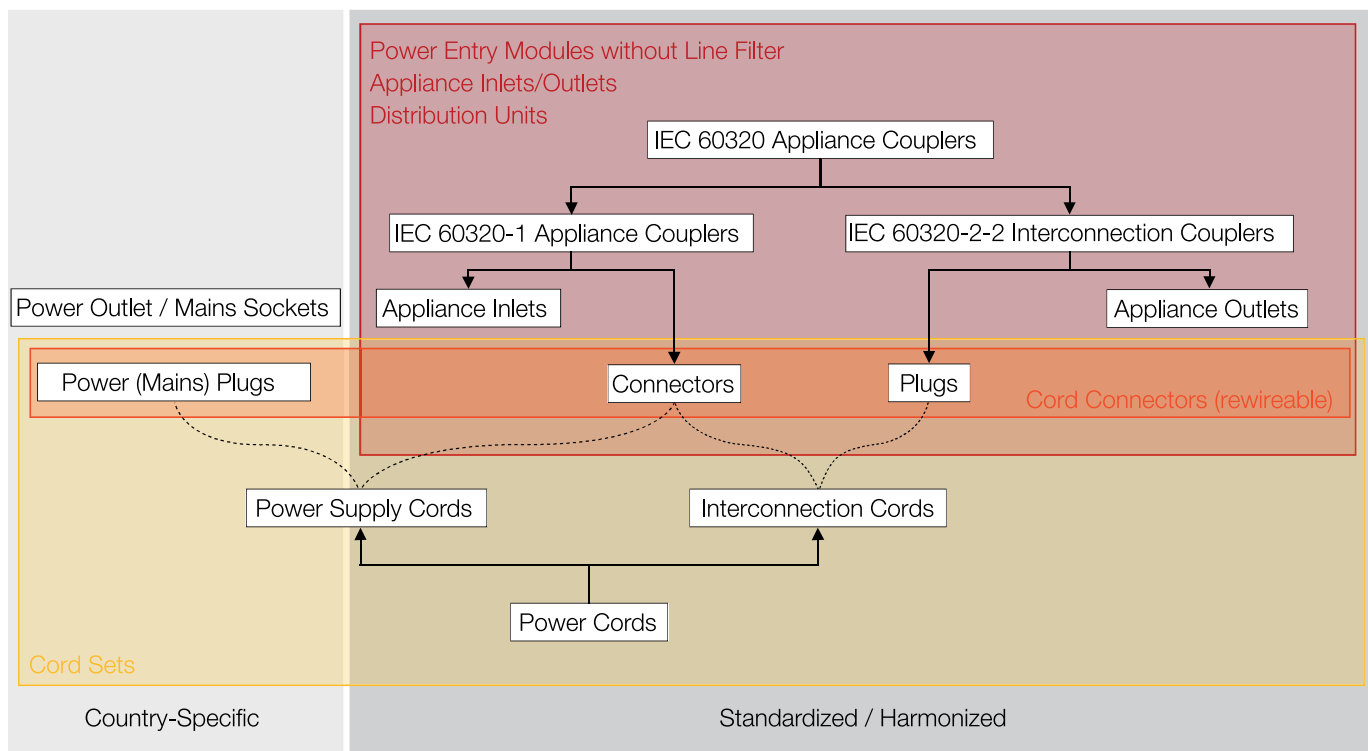









General Product Information

Application area

Two-pole AC-only appliance couplers, with or without earthing contact, rated for voltages up to 250VAC and nominal currents of up to 16A, used for connecting a flexible power supply cord to electrical appliances or other electrical installations at 50 or 60Hz (cf. IEC 60320-1 http://www.schurter.ch/products/iec_connector_overview.asp?active=4#7.3).

Two-pole AC-only interconnection couplers, with or without earthing contact, rated for voltages up to 250VAC and nominal currents of up to 16A, used for interconnecting the power supply and appliances or installations at 50Hz or 60Hz (cf. IEC 60320-2-2 http://www.schurter.ch/products/iec_connector_overview.asp?active=4#7.4).

Requirements / categories

Parameter	Example		Distinguishing Features		
Protection Class	<p>C14</p>  <p>Protection Class I</p>	<p>C18</p>  <p>Protection Class II</p>	with / without earth conductor contact		
Rated Current	<p>C8 A</p>  <p>2.5A</p>	<p>C9</p>  <p>6A</p>	<p>C14</p>  <p>10A</p>	<p>C20</p>  <p>16A</p>	varying plug outlines
Pin Temperature	<p>C14</p>  <p>70°C</p> <p>for cold applications</p>	<p>C16</p>  <p>120°C</p> <p>for hot applications</p>	<p>C16 A</p>  <p>155°C</p> <p>for very hot applications</p>	plug outlines feature additional notches	

Pin temperature

The requirements placed on connectors are contingent on the maximum temperature of the corresponding appliance inlets, i.e.:

Plug Temperature	corresponds to	Comment
70°C	Appliance couplers for cold conditions	(colloquially referred to as a 'cold condition' appliance couplers)
120°C	Appliance couplers for hot conditions	(colloquially referred to as a 'warm condition' appliance couplers acc. translation of a German terminology)
155°C	Appliance couplers for very hot conditions	(colloquially referred to as a 'hot condition' appliance couplers)

'Cold condition' appliance inlets may not be used in appliances with exterior parts whose temperature increase can exceed 75K and which, when used properly, can come into contact with the movable power cord.

Nominal currents

According to IEC 60320, the following nominal currents apply: 2.5A / 6A / 10A / 16A. The nominal current ratings of SCHURTER's components are based on the relevant approval standards which may differ from one country to another (see Approval Bodies http://www.schurter.ch/support/approval_industry_links.asp). The table below shows the differences between the IEC's nominal current ratings and those approved by VDE, UL and CSA (SCHURTER reference compo-

nents). IEC 60320, to prevent improper use, provides for contour coding for the nominal currents listed above.

IEC	VDE	UL	CSA
2.5 A	2.5 A max.	2.5 A	6 A max.
6 A	6 A max.	n/a	n/a
10 A	10 A max.	15 A max.	16 A max.
16 A	16 A max.	20 A max.	21 A max.

Protection classes according to IEC 60536

With regard to protection against direct contact, the appliance couplers are categorized as follows:

- Class 1 appliances (with earth conductor)
- Class 2 appliances (without earth conductor)

See detailed explanations on Electric Shock Protection http://www.schurter.ch/products/iec_connector_overview.asp?active=2#6

Special designs

Appliance couplers in compliance with the present standards are designed to connect appliances without special protection against humidity (see IP Protection Class http://www.schurter.ch/products/iec_connector_overview.asp?active=2#5). Appliances whose operation, when used properly, may involve overflowing liquids or dust emissions must themselves be protected against humidity. IEC standard 60320-2-3 provides that the power supply's IP protection rating must

General Product Information

be at least identical to that of the appliance. Special designs may also become necessary in environments involving special conditions (e.g. on ships or in motor vehicles) and in dangerous locations (e.g. involving explosives).

SUITABLE APPLIANCE COUPLERS

Suitable appliance couplers according to IEC 60320-1

The suitable connection options for appliance couplers are listed below. The appliance couplers' contours are coded (type, symbol) so as to allow a 'hot condition' connector to fit into a 'cold condition' appliance inlet, but not vice versa. Important note: The appliance inlet nominal current rating must be at least identical to that of the appliance!

Mating Appliance Coupler IEC60320-1				Appliance Inlets														
	Symbol	Type	Current [A]	Temperature [°C]	Gender Male													
					Plugs													
					A		C		E		G		I		K			
					Type	Current [A]	Type	Current [A]	Type	Current [A]	Type	Current [A]	Type	Current [A]	Type	Current [A]		
					1	2	1	2	1	2	1	2	1	2	1	2	1	2
IEC60320 Connectors Gender Female	C5	2.5	70	1	•													
	C7	2.5	70	2		•												
	C7p	2.5	70	2			•											
	C9	6	70	2				•										
	C13	10	70	1					•									
	C15	10	120	1						•								
	C15A	10	155	1							•							
	C17	10	70	2								•						
	C19	16	70	1									•					
	C21	16	155	1										•				
	C23	16	70	2											•			

Combinations according to IEC 60320-1: • intended, possible
The available product combinations can be selected under 'Mating IEC Connectors <http://www.schurter.ch/wwwmc/wwwmc.asp>'.

Suitable Interconnection Couplers according to IEC 60320-2-2

The suitable connection options for interconnection couplers are listed below. The regulatory framework applicable here is identical to that governing IEC 60320-1 http://www.schurter.ch/products/iec_connect

tor_overview.asp?active=4#7.3.

Mating Appliance Coupler IEC60320-1				Plugs														
	Symbol	Type	Current [A]	Temperature [°C]	Gender Male													
					Plugs													
					A		C		E		G		I		K			
					Type	Current [A]	Type	Current [A]	Type	Current [A]	Type	Current [A]	Type	Current [A]	Type	Current [A]		
					1	2	1	2	1	2	1	2	1	2	1	2	1	2
IEC60320 Connectors Gender Female	C5	2.5	70	1	•													
	C7	2.5	70	2		•												
	C13	10	70	1				•										
	C15	10	120	1					•									
	C15A	10	155	1						•								
	C17	10	70	2							•							
	C19	16	70	1								•						
	C21	16	155	1									•					
	C23	16	70	2											•			

Combinations according to IEC 60320-1: • intended, possible

The available product combinations can be selected under 'Mating IEC Connectors <http://www.schurter.ch/wwwmc/wwwmc.asp>'.

Mating Interconnection Coupler IEC 60320-2-2				Plugs														
	Symbol I	Type e	Current [A]	Temperature [°C]	Gender Male													
					Plugs													
					A		C		E		G		I		K			
					Type	Current [A]	Type	Current [A]	Type	Current [A]	Type	Current [A]	Type	Current [A]	Type	Current [A]		
					1	2	1	2	1	2	1	2	1	2	1	2	1	2
IEC 60320 Appliance Outlets Gender Female	B	2.5	70	1	•													
	D	2.5	70	2		•												
	F	10	70	1				•										
	H	10	70	2					•									
	J	16	70	1						•								
	L	16	70	2								•						

Combinations according to IEC 60320-2-2: • intended, possible

Contact Configuration

On standard, non-reversible appliance inlets/outlets, the contacts, when viewing the engagement surfaces from above, must be configured as follows:



Appliance Inlet



Connector



Plug



Appliance outlet

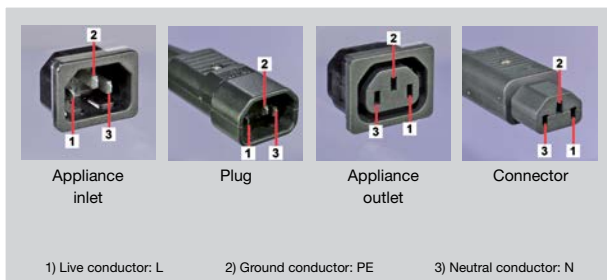

General Product Information

EXPLANATION OF TERMS

Explanation of IEC 60320 connector terms

The illustration below shows a possible component configuration, properly naming the various components which will be explained in detail further down, including the distinguishing characteristics.

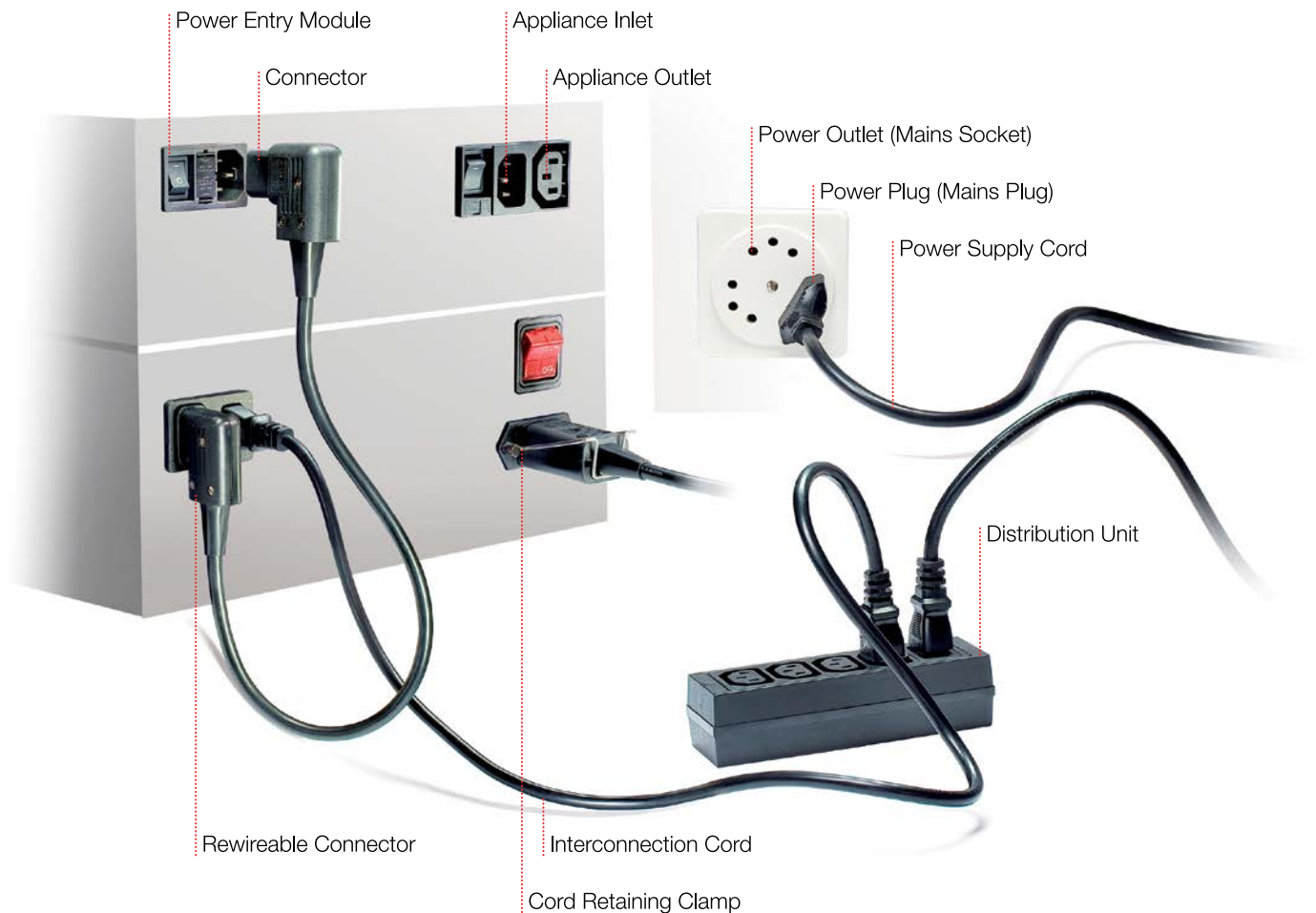

Appliance coupler

Appliance coupler means devices for connecting a flexible power cord to an appliance or another installation. You will find a product overview under 'Gerätestecker http://www.schurter.ch/products/connectors_filters_overview.asp?Mating_Connectors'. Appliance couplers essentially comprise the following components:

- Connector
- Appliance Inlet

Interconnection cords



Interconnection cords means structural units consisting of a flexible cord fitted with a plug and a connector built for interconnecting or disconnecting any appliance or installation with/from any other appliance or installation by means of a power cord. You will find a product over-

view under 'Cord Sets http://www.schurter.ch/wwwsc/con_pg07_2.asp?language_id=10'. Configurator http://www.schurter.ch/wwwpc/configurator_overview.asp?language_id=10 | Webselector Chart http://www.schurter.ch/wwwsc/con_pg07_2.asp?language_id=10 | Mating Connector <http://www.schurter.ch/wwwmc/wwwmc.asp>

Rewireable plug and connectors



Rewireable plugs and connectors means structural units built to allow the flexible cord to be exchanged/replaced, colloquially referred to as 'cord plugs/connectors'. You will find a product overview under 'Cord Connectors http://www.schurter.ch/wwwsc/con_pg07b.asp?language_id=10'. That overview also includes the power plugs available. Configurator http://www.schurter.ch/wwwpc/configurator_overview.asp?language_id=10 | Webselector Chart http://www.schurter.ch/wwwsc/con_pg07b.asp?language_id=10 | Mating Connector <http://www.schurter.ch/wwwmc/wwwmc.asp>

General Product Information

schurter.ch/wwwmc/wwwmc.asp

Non-rewireable plug and connectors



Non-rewireable plugs and connectors means structural units which, in contrast to removable plug and connectors, are built to form an integrated, inseparable whole with the flexible cord. You will find a product overview under 'Cord Sets http://www.schurter.ch/wwwsc/con_pg07_2.asp?language_id=10'. Configurator http://www.schurter.ch/wwwpc/configurator_overview.asp?language_id=10 | Webselector Chart http://www.schurter.ch/wwwsc/con_pg07_2.asp?language_id=10 | Mating Connector <http://www.schurter.ch/wwwmc/wwwmc.asp>

Power supply cords



Means structural units consisting of a flexible cord fitted with a power (mains) plug and a connector for connecting an electrical appliance to the power supply. You will find a product overview under 'Cord Sets http://www.schurter.ch/wwwsc/con_pg07_2.asp?language_id=10'. Configurator http://www.schurter.ch/wwwpc/configurator_overview.asp?language_id=10 | Webselector Chart http://www.schurter.ch/wwwsc/con_pg07_2.asp?language_id=10 | Mating Connector <http://www.schurter.ch/wwwmc/wwwmc.asp>

Power entry modules with or without filter



Means power entry modules (PEM), i.e. modules including different functional elements, such as:

- IEC appliance inlet / outlet
- switch including bowden cable actuation
- circuit breaker
- fuseholder
- voltage selector
- EMC filter

The advantages of PEM over individual components include:

- compact design
- only one product with electrically linked individual components
- efficient assembly
- alternative design options with similar dimensions
- Protected, assembled and already tested/approved power supply components

You will find a detailed product overview under 'Power Entry Modules without Filter http://www.schurter.ch/wwwsc/con_pg05.asp?language_id=10' and 'Power Entry Modules with Filter http://www.schurter.ch/wwwsc/con_pg06.asp?language_id=10'.

IEC appliance inlets / outlets



The IEC appliance inlets and outlets correspond to the individual components already presented in compliance with the IEC's appliance couplers standards. You will find a detailed product overview under 'appliance inlets/outlets http://www.schurter.ch/wwwsc/con_pg07.asp?language_id=10'.

A specific approach is the shuttered outlet that protects unintended contact with live parts by movable protection shutters. They will be moved away by the insertion of the plug connector. The product is herewith ideally suitable to be used in applications to be used by children.

A special design is the protected outlet. The individual connections of a distribution unit can be limited by its power consumption by using a fuse-link http://www.schurter.ch/wwwsc/con_pg02.asp?language_id=10. The optional neon indicates the correct operation stage of the power line.

Configurator http://www.schurter.ch/wwwpc/configurator_overview.asp?language_id=10 | Webselector Chart http://www.schurter.ch/wwwsc/con_pg07.asp?language_id=10 | Mating Connector <http://www.schurter.ch/wwwmc/wwwmc.asp>

EMC filters

Ensuring the electromagnetic compliance (EMC) of specific appliances may necessitate the use of filter components, colloquially referred to as inlet filters or IEC inlet filters. Filters may also be used in addition to the PEM described above. You will find a detailed product overview under 'Power Entry Modules with Filter http://www.schurter.ch/wwwsc/con_pg06.asp?language_id=10'.

Distribution units



Means components used to, for instance, supply a multitude of appliances equipped with IEC appliance couplers with power from only one country-specific power supply cord via several interconnection cords. You will find a detailed product overview under 'Distribution Units http://www.schurter.ch/wwwsc/con_pg07_1.asp?language_id=10'. Since, due to the lack of standards, distribution units have only limited UL and VDE approval, modular solutions assembled from approved individual components (inlets/outlets) have been made available. The applicable nominal voltage, the cord retainers and the necessary conductor cross-sectional areas (gauge) can be specifically selected depending on the relevant application area.

Covers

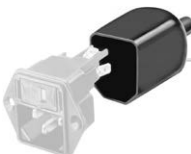

Protective caps or covers for appliance inlets and power entry modules prevent inadvertent contact with the live parts on the appliance's interior. They are made from flexible plastic and can be pushed onto the components from the rear. Compatibility information on the various types of covers is available in a relevant data sheet.

General Product Information

Cord retaining clamps

Cord retaining clamps ensure firm push-on connections. The compatibility of the selected appliance couplers is imperative for reliable protection. You will find a detailed product overview on cord retaining clamps in the chapter "pullout prevention on pluggable power supplies".

COMPONENTS FOR POWER ENTRY MODULS

LINE SWITCH

Switches including Bowden cable actuation

Switches can be built both as 1-pole (phase conductor disconnection) and 2-pole (phase and neutral conductor disconnection) units to ensure compliance with the relevant power supply standards. As a matter of principle, high-quality products are used which meet the current requirements and which are well within the given nominal current boundaries as defined by the IEC 60320 standard http://www.schurter.ch/products/iec_connector_overview.asp?active=5#7.5.1 on appliance couplers.

Line switch used by type	Technical data	
CMF1, CMF2, CMF3, CMF4	Electrical rating acc. to IEC/EN 61058-1	10 (4) A / 250 VAC, 10 000 switch operations 6 (4) A / 250 VAC, 50 000 switch operations Statement in () at inductive load with p. f. 0.6
	Electrical rating acc. to UL 1054	6 A, 125–250 VAC, 6000 switch operations (1/4) HP, 125 VAC (1/2) HP, 250 VAC Statement in () at inductive load with p. f. 0,45
	Inrush current acc. to IEC/EN 61058-1	capacitive 70 A, 3–4 ms continuous current 5 A 10 000 switch operations
	Contact gap	≥3 mm
KM, KMF, PMM, GRM1, GRM2, GRM4	Electrical rating acc. to IEC/EN 61058-1	10 (4) A / 250 VAC, 10 000 switch operations 6 (4) A / 250 VAC, 50 000 switch operations Statement in () at inductive load with p. f. 0.6
	Electrical rating acc. to UL 1054	12 A, 125–250 VAC, 6000 switch operations (1/3) HP, 125 VAC (1/2) HP, 250 VAC Statement in () at inductive load with p. f. 0.45 Meets switching current test acc. to UL 1054, TV-3
	Inrush current acc. to IEC/EN 61058-1	capacitive 100 A, 3–4 ms continuous current 5 A 10 000 switch operations
	Contact gap	≥3 mm
KEB1, KFB1	Electrical rating acc. to DIN/VDE 0630	12 (3) A / 250 VAC, 10 000 switch operations Statement in () at inductive load with p. f. 0.6
	Inrush current acc. to IEC/EN 61058-1	capacitive 20 A, < 5 ms continuous current 5 A 10 000 switch operations
	Contact gap	≥3 mm
DC11, DC12, DC21, DC22, DD11, DD12, DD21, DD22	Electrical rating acc. to IEC/EN 61058-1	16 (4) A / 250 VAC, 10 000 switch operations 10 (4) A / 250 VAC, 50 000 switch operations Statement in () at inductive load with p. f. 0.6
	Electrical rating acc. to UL 1054	16 A / 125–250 VAC, 6000 switch operations (1) HP 125 VAC / (2) HP 250 VAC Statement in () at inductive load with p. f. 0.45
	Inrush current acc. to IEC/EN 61058-1	capacitive 100 A, 3–4 ms continuous current 5 A
KP (Schalter), KEB2, KFB2, KD, CD, KG, CG, Felcom 54, Felcom 64, FKH, FK1, FKHD, FKID	Electrical rating acc. to IEC/EN 61058-1	12 (4) A / 250 VAC, 10 000 switch operations 8 (8) A / 250 VAC, 50 000 switch operations Statement in () at inductive load with p. f. 0.6

General Product Information

Line switch used by type	Technical data	
	Electrical rating acc. to UL 1054	15 A, 125–250 VAC, 6000 switch operations (3/4) HP, 125 VAC (1 1/2) HP, 250 VAC Statement in () at inductive load with p. f. 0.45 Meets switching current test acc. to UL 1054, TV-3
	Inrush current acc. to IEC/EN 61058-1	capacitive 70 A, 3–4 ms continuous current 5 A 10 000 switch operations
	Contact gap	≥3 mm
KD Bowden cable, CD Bowden cable, KG Bowden cable, CG Bowden cable	Electrical rating acc. to IEC/EN 61058-1	6 (4) A / 250 VAC, 10 000 switch operations Statement in () at inductive load with p. f. 0.6
	Electrical rating acc. to UL 1054	6 A, 250 VAC, 10 000 switch operations 8 A, 125 VAC, 10 000 switch operations
	Inrush current acc. to IEC/EN 61058-1	capacitive 36 A, < 5 ms continuous current 6 A 6000 switch operations
	Contact gap	≥3 mm
EC11, EC12	Electrical rating acc. to IEC/EN 61058-1	16 (4) A / 250 VAC, 10 000 switch operations 10 (4) A / 250 VAC, 50 000 switch operations Statement in () at inductive load with p. f. 0.6
	Electrical rating acc. to UL 1054	20 A, 125–250 VAC, 6000 switch operations (1) HP, 125 VAC (2) HP, 250 VAC Statement in () at inductive load with p. f. 0.45 Meets switching current test acc. to UL 1054, TV-3
	Inrush current acc. to IEC/EN 61058-1	capacitive 100 A, 3–4 ms continuous current 5 A 10 000 switch operations
	Contact gap	≥3 mm

Bowden cable for type KD/KG, CD/CGD/CG

Remote actuator technology

The remote actuator cable assembly consists of a wire cable inside of a plastic insulated spiral wire casing. Identifying a proper routing of the cable assembly is important. Deviations from line to line placement will require bends in the cable with resulting losses in the overall assembly. These inefficiencies show up as friction losses and lost motion. Frictional losses are increases in actuation force due to losses in the assembly. Lost motion is an undesirable difference between the input end of the assembly and the output end. The principle element of lost motion is backlash and deflection. Backlash is caused by the wire cable moving inside the casing with the change in direction of motion. It is the function of clearance between the wire cable and casing, plus the number of degrees of bend in the cable assembly. Deflection of the cable assembly, while usually low, can be minimized by anchoring the casing. This is especially true in those applications of cable assemblies with long lengths and/or large degrees of bend in the system. All of these losses and resulting inefficiencies can be reduced by the equipment designer through minimizing the total degrees of bend in the assembly. Because of the number of variables effecting proper operation of any remotely actuated switch assembly, it is important that the ordering instructions be used to determine proper cable length and to provide samples for customer approval.

Consult figure for minimum information required to describe cable assembly application.

Order details and description

How to specify length of Bowden cable

R Mounting parallel to direction of actuation

B1 Actuating part

B2 Power entry module

Dimensions in mm (center of mounting hole [B1], outer surface to center of mounting hole [B2], outer surface)

R a/ b c/

S Mounting 90° to direction of actuation

B1 Actuating part

B2 Power entry module

Dimensions in mm (center of mounting hole [B1], outer surface to center of mounting hole [B2], outer surface)

S a/ b/ c/

Ordering example

1. Order No. socket KD14.4199.151
2. Order No. fuse drawer 4303.2024.03
3. Bowden cable (type of mounting / dimensions in mm) * R a/200 b/180 c/40

*The order No. for a customer specific Bowden cable you'll get with the acknowledgment.

Delivery time for a customer specific Bowden cable sample approx. 2 weeks.

Standard Bowden cable sample, Order No. 0886.0101, ex stock

Circuit breakers for equipment

In addition to switching, a Circuit Breakers for Equipment http://www.schurter.ch/products/cb_overview.asp?language_id=10 (CBE) ensures protection against overload. You will find detailed information on Circuit Breakers for Equipment http://www.schurter.ch/products/cb_overview.asp?language_id=10 as well as a product overview of Power

General Product Information

Entry Modules with CBE http://www.schurter.ch/wwwsc/con_pg19_1.asp?language_id=10 in the product overview under 'Circuit Breakers for Equipment'.

FUSE DRAWER

Fuseholders, part of a power entry module

Fusedrawer 1 http://www.schurter.ch/pdf/english/typ_Fusedrawer_1.pdf

Fusedrawer 2 http://www.schurter.ch/pdf/english/typ_Fusedrawer_2.pdf

Fusedrawer 3 http://www.schurter.ch/pdf/english/typ_Fusedrawer_3.pdf

Explanations, thermal requirements, selection criteria

Protection against electric shock (against direct contact with live parts) for fuseholders

The assessment of the protection against electric shock assumes that the fuseholder is properly assembled, installed and operated as in normal use, e.g. on the front panel of the equipment. IEC 60127-6 and EN 60127-6 divides into three categories:

Cate- gory	Features
PC1	Fuseholders without integral protection against electric shock. They are only suitable for applications where corresponding additional means are provided to protect against electric shock.
PC2	Fuseholders with integral protection against electric shock live part is not accessible: - when the fuseholder is closed - after the fuse carrier (incl. fuse-link) has been removed - either during insertion or removal of the fuse carrier (incl. fuse-link) Compliance is checked by using the standard test finger specified in IEC 60529.
PC3	Fuseholder with enhanced integral protection against electric shock The requirements for this category are the same as those for category PC2, with the exception that the testing is carried

Extra-safe handling with SCHURTER power entry modules

Protection against contact with live parts is an important aspect when dealing with electrical connecting devices. Both your customers and your servicing engineers will appreciate the greatest possible protection against accidental contact with live parts – something which can easily happen as a result of inappropriate use, or during servicing or repair work.

In particular, our “shock-safe”, “extra-safe fuse-drawers” and “protective covers” precautions are effective ways of protecting against accidental contact when using the power entry modules.

Example: Power entry module with fuseholder, shocksafe category PC2

Closed fuseholder and appliance inlet.

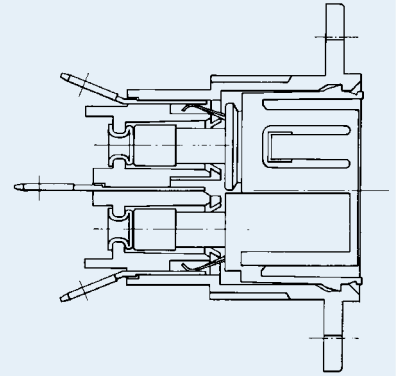

It is not possible to touch any live parts on the SCHURTER fuseholders when the fuse-carrier is extracted.

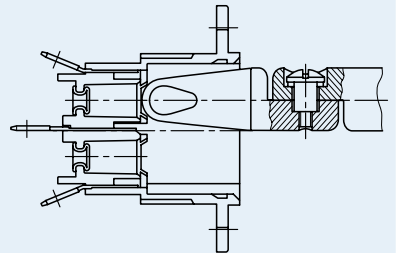

When a fuse-link 5 x 20 mm or 6,3 x 32 mm (1/4" x 11/4") is inserted or replaced, neither the fuse nor the fuse-carrier can come in contact with any live parts.

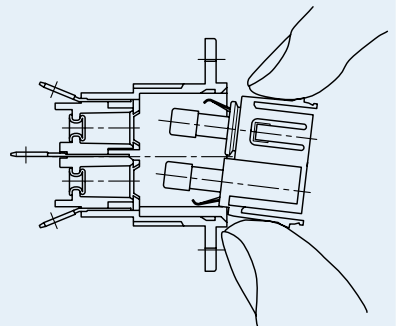

The extra-safe versions of shock-safe power entry modules are now available.

They are thus also able to satisfy requirements of the following standard: IEC 60601-1 (medical equipments).

The drawer can only be extracted with the aid of a tool (e.g. screwdriver) so that opening by hand is quite impossible.

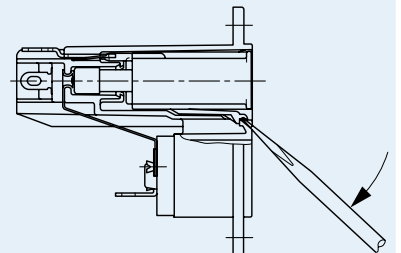

General Product Information

With some types it is also necessary to pull out the mains outlet first. Only then can the drawer be removed from the socket.

The drawer can then be removed by hand.

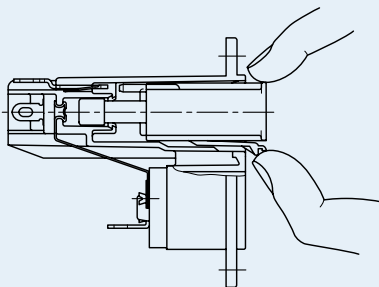

Fuseholder surface area	Maximum allowable temperature measuring points (see figure 1)	
		°C
1. Accessible parts ¹⁾	T_{S1}	85
2. Inaccessible parts ¹⁾ Insulating parts	T_{S2}	²⁾

NOTES:

1) When the fuse-holder is properly assembled, installed and operated as in normal use, e.g. on the front panel of equipment.

2) The maximum allowable temperature of the used insulating materials corresponds to the Relative Temperature Index (RTI) according to IEC 60216-1 or UL 746 B.

Influencing factors

The design engineer of electrical equipment is responsible for its safety and functioning to humans, animals and real values. Above all, it is his task to make sure that the state of the art as well as the valid national and international standards and regulations be observed.

In view of the safety of electrical equipment the selection of the most suitable fuseholder is of great importance. Among other parameters, one has to make sure that the maximum admissible power acceptances and temperatures defined by the manufacturer are followed. Differing definitions and requirements in the most important standards for fuse-links and fuseholders are time and again origin for the incorrect selection of fuseholders.

To equate the rated current of a fuse-link with the rated current of the fuseholder, may, especially at higher currents, cause high, not admissible temperatures, when the influence of the power dissipation in the contacts of the fuseholder was not taken into consideration.

For a correct selection the following influence factors depending on the application and mounting method, have to be followed:

1. Rated power dissipation of the suitable fuse-link.
2. Admissible power acceptance, operating current and temperatures of the suitable fuseholder.
3. Differing ambient air temperature outside and inside of the equipment.
4. Electrical load alternation
5. Long time (> 500 h) operation with load > 0.7 I_n .
6. Heat dissipation/cooling and ventilation. Heat influence of adjacent components.
7. Length and cross section of the connecting wire.

Rated current of a fuseholder

The value of current assigned by the manufacturer of the fuseholder and to which the rated power acceptance is referred.

Rated power dissipation of the fuse-link

(power dissipation at rated current)
See sep. catalogue "fuses".

Rated power acceptance and admissible temperatures of a fuseholder

The rated power acceptance of a fuseholder is determined by a standardised testing procedure according to IEC 60127-6. It is intended to be the power dissipation caused by the inserted dummy fuse-link at the rated current of the fuseholder and at an ambient air temperature of $T_{A1} = T_{A2} = 23\text{ °C}$ (over a long period). During this test the following temperatures must not be exceeded on the surface of the fuseholder:

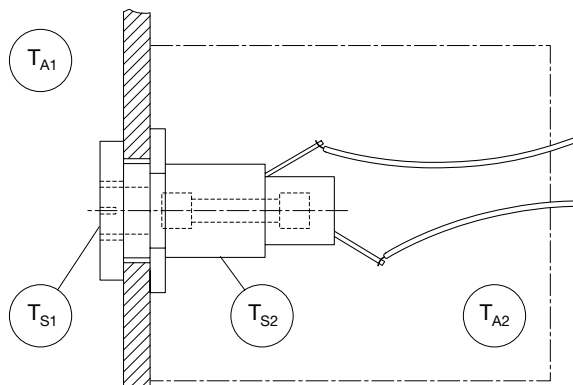

Illustration of temperatures experienced

T_{A1} = ambient air temperature, surrounding the equipment

T_{A2} = ambient air temperature in the equipment

T_{S1} = temperature of accessible parts on fuseholder surface

T_{S2} = temperature of inaccessible parts on fuseholder surface

Correlation between operating current I , ambient air temperature T_{A1} and the power acceptance P_h of the fuseholder

This correlation is demonstrated by derating curves.

Example of a derating curve

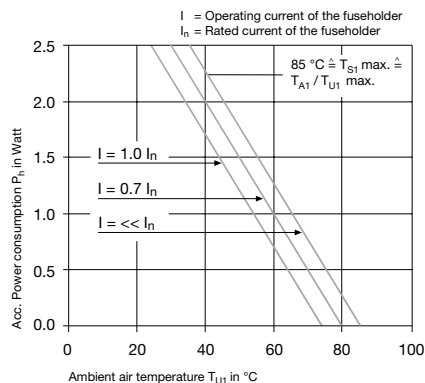

I = operating current of the fuseholder

I_n = rated current of the fuseholder

The derating curves demonstrate the admissible power acceptance of a fuseholder depending on the ambient air temperature T_{A1} for the following fuseholder operating currents: $I << I_n$, $I = 0,7 \cdot I_n$ and $I = 1,0$.

General Product Information

I_n . This power acceptance corresponds to the max. admissible power dissipation of a fuse-link.

A calculation example can be looked up in the technical information for fuses.

VOLTAGE SELECTORS

Operating appliances in international markets requires taking into account the country-specific power supply systems. An appliance capable of operating under different voltages must allow the user to select and display such voltages. SCHURTER provides three differently configurable voltage selectors for such purposes.

Voltage Selector http://www.schurter.ch/pdf/english/typ_Voltage_Selectors_Insert_1.pdf

Series-parallel connection

System No. 12 separate windings, one with a tap3 or 4 switch positions
2 separate windings one with a tap3 or 4 switch positions

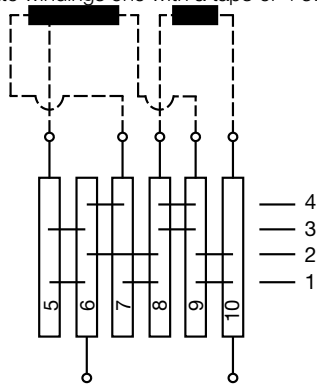

Allows the user to achieve a multitude of line voltages with one transformer with three primary windings and one secondary winding.

Step switch

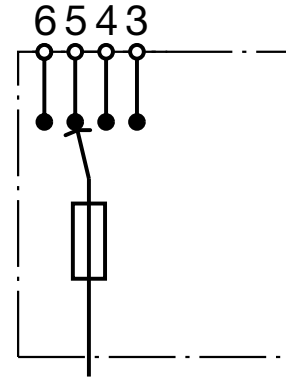

This circuit allows the user to select up to four primary voltages.

Jumper

Voltage selector

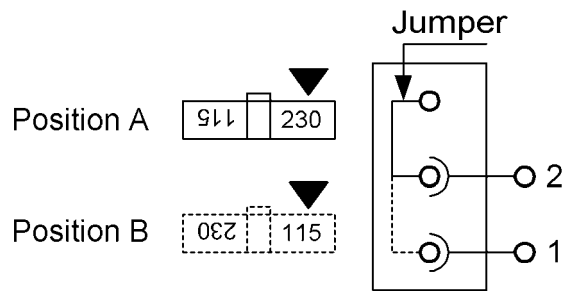

The easiest way to set only two voltages is by using a jumper.

General Product Information

MOUNTING

Mounting appliance couplers

Different applications require different approaches to the optimal mounting of appliance inlets and outlets, taking into account both minimal dimensions and customer-specific assembly methods, e.g. the module design possibilities that allow electrical testing even before mounting.

Mounting side

Mounting appliance inlets and outlets into front panels is possible both from the front (exterior of the appliance's mounting board) and from the rear (interior of the appliance's mounting board) to respond to different customer-specific assembly scenarios.



Usually, the appliance couplers are, together with other control components, mounted (and then wired) from the front into the appliance's housing. Under certain circumstances it is practical to test the entire electrical unit before mounting. In such cases it is imperative that the appliance coupler be mounted from the rear.

Mounting method

The mounting method describes the procedure of mounting the appliance coupler onto the mounting board.

Snap-in mounting

Snap-in mounting facilitates the insertion of the appliance coupler into the properly prepared panel cutout. Mounting is done by locking snap-in lugs or snap locks (parts of the supplied component) into place.

Usually, snap-in mounting is done from the front.

We distinguish between three categories:

One-step snap lock



This snap lock fits perfectly when mounted onto a board with the same thickness as specified in the relevant data sheet.

Incremental snap lock



This snap lock fits perfectly when mounted onto boards with the same respective thicknesses as specified in the data sheet. Hence one product can be used for different housing systems, provided that their panel thicknesses match the snap lock's specs.

Universal snap lock



Universal snap locks do not require a specific panel thickness. They fit perfectly when mounted onto boards with any thickness within the range specified in the relevant data sheet.

Screw-on mounting



Screw-on mounting is largely independent from panel thickness and ensures better firmness. Mounting can be done both from the front and the rear; however, in contrast to snap-in mounting, this method requires screws and possibly nuts as well (which are not included, unless specified otherwise). For safe mounting, the specified screw tightening torques must be observed, in order to prevent damaging the component while ensuring secure fastening.

The standard version is mounted using countersunk head screws. Depending on the information in the data sheet, other product types, i.e. with a through hole or flat head machine screws, may be used.

A special type of screw-on mounting appliance coupler comes with the tapped holes for screw-on mounting already in place on the mounting flange, thus reducing the number of components which, in specific cases, may also ensure the product's tightness to the mounting board (see 5707)

Sandwich mounting



Sandwich mounting makes it possible to mount appliance couplers without the need for additional components. Mounting can be done both from the front and the rear, as specified in the relevant data sheet.

Mounting instructions

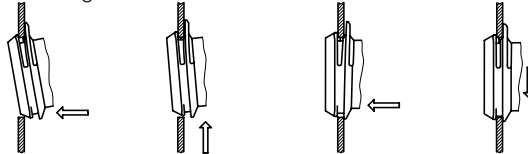

Rivet mounting

Rivet mounting is essentially identical to screw-on mounting when using the mounting holes as through holes or using flat head machine screws with the corresponding dimensions as specified in the relevant data sheet.

Mounting position

The mounting position indicates, with regard to the connector pin's orientation, on what side the mounting elements are, treating snap-in and screw-on positions identically.

General Product Information



TERMINALS

The appliance couplers' terminals refer to the contacts on the appliance's interior, designed according to the customers' individual needs. We distinguish between the following types:

Solder tabs



The solder tab is a plated metal tongue for fastening a connecting stranded wire by soldering it on. The solder tabs' geometry may vary. The corresponding connection dimensions are listed in the relevant data sheet.

PCB connectors



The PCB connector is a plated metal contact for soldering onto a contact conductor's contact point on a PCB. We basically distinguish between Through-Hole Technology (THT) and Surface Mount Technology (SMT). The connections' geometry is specified in the relevant data sheet.

Quick-connect terminals



Quick connect, push-on or blade terminals feature metal blades with standardized dimensions. They are also referred to as faston terminals, typically measuring 4.8 x 0,8 mm, 6.3 x 0,8 mm. The terminal dimensions are specified in the relevant data sheet. Correspondingly, the connecting stranded wires must be fitted with flat pin bushings of identical dimensions.

IDC terminals



In IDC terminals respectively connectors (IDC meaning 'Insulation Displacement Connector'), the strands of the connecting stranded wire or wire are, without prior preparation of the power cord, pushed onto the insulation cutting terminal, the terminal cutting the insulation open and the clamping connection fastening the stranded wire or wire ensuring

the electrical connection. In order to ensure a perfect connection, the conductors' cross-sectional areas as specified in the relevant data sheet must be observed.

Screw-on terminals



Screw-on terminals are simple clamp fasteners using stud screws for fastening the connecting stranded wires.

Stranded wires



Power supply is also possible without using additional cabling components, because appliance couplers are available pre-fitted with the connecting stranded wires. Stranded wires pre-fitted with plugs are also available upon request for mounting the power entry module into the target appliance without the need for any further process steps.

Wire Harnessing

WIRE HARNESS

The wire harness service includes several types of ready to install wires, cables or wire harnesses with custom specific end terminal connections. The SCHURTER products such as IEC 320 connectors, power entry modules or filter products with quick connect, solder or screw on terminals can be assembled with above custom specific interconnection solutions.

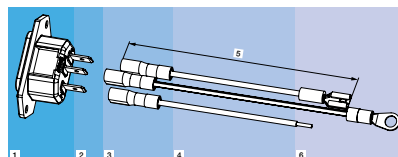

1) SCHURTER connector type, 2) Connector terminals, 3) Receptacles, 4) Wire-type and colour, 5) Wire length, 6) Wire end terminal

Connector / power entry module products

As power entry elements or so-called PEM (Abbreviation for Power Entry Module) refer to items that contain, in addition to a pure plug-in device more functional elements, such as switch, circuit breaker, fuse holder, voltage selector.

EMC connector filter

EMC connectors and PEMs are IEC60320 inlets equipped with an EMC filter function and provide the necessary attenuation to meet in the stringent EMC requirements in the various application fields.

The above-mentioned components with various interconnection terminal types such as quick connect, solder or screw-on terminals are available with wire harness (for details see catalogue data sheet respectively the WEB selector).

General Product Information

Quick connect / fast-on terminals



The quick connect or fast-on terminals correspond to metal mounting clamps with standard dimensions, typically in the size of 4.8 x 0.8 mm, 6.3 x 0.8 mm. The dimensions of the connections are specified in the product data sheet of the connector or power entry module component. Accordingly, the flexible wire end needs to be assembled by a quick connect terminal of a female type with the same dimensions.



Quick connect terminals 4.8 x 0.8 mm or 6.3 x 0.8 mm



Terminal ring M4 and M5

Solder terminals



Solder connections are made of a coated metal tab for attaching a flexible wire by soldering. The soldering terminals may be of geometrically different characteristics. The dimensions of the solder terminals are given in the product catalogue data sheet.



Wire end stripped



Custom specific

Screw-on terminals



Screw on terminals are clamp fixtures, connecting flexible wires using threaded pins or wholes with screws or nuts.

Flexible wires

Wires used will be available as AWG18, AWG16, AWG14 cables according UL3266 in standard colours such as brown, black, bright blue, yellow-green and customized lengths. (AWG stands for American Wire Gauge and is a coding for wire diameter, which is mainly used in North America. It features electric lines of stranded and solid wire and is used mainly in electrical engineering to describe the cross section of wires.)



Wire end terminals

The connections of the wire harness are determined by the selected Power Entry Module part. At the free end the flexible wires are individually assembled to customers' specifications. Standard connections are provided as for example quick connect terminals 6.3 mm or 4.8 mm, ring terminals M4 or individual leads. Connections are possible with a full insulation, partly insulated or without.

Description	AWG	mm ²	Manufacturer	No.	UL number	Sysa art. No.
Terminal ring insulated M5	22 - 18	0.5 - 1.5	Panduit	PMN1-SR-3K	E78522	EL-29650
Terminal ring insulated M5	16 - 14	1.5 - 2.5	Panduit	PMN2-SR-3K	E78522	EL-29651
Terminal ring insulated M4	22 - 18	0.5 - 1.5	Panduit	PMN1-4R-3K	E78522	EL-29652
Terminal ring insulated M4	16 - 14	1.5 - 2.5	Panduit	PMN2-4R-3K	E78522	EL-29653
Quick connect terminal 6.3x0.8mm insulated PA	22 - 18	0.5 - 1.5	Panduit	DMNF1-63FB-3K	E78522	EL-29658
Quick connect terminal 6.3x0.8mm insulated PA	16 - 14	1.5 - 2.5	Panduit	DMNF2-63FB-3K	E78522	EL-29659
Quick connect terminal 4.8x0.8mm insulated PA	22 - 18	0.5 - 1.0	Panduit	DMNF1-48FB-3K	E78522	EL-29660
Quick connect terminal 4.8x0.8mm insulated PA	16 - 14	1.5 - 2.5	Panduit	DMNF2-48FB-3K	E78522	EL-29661
Quick connect terminal 6.3x0.8mm insulated PVC	22 - 18	0.5 - 1.0	Panduit	DMV1-63B-3K	E78522	EL-29662
Quick connect terminal 6.3x0.8mm insulated PVC	16 - 14	1.5 - 2.5	Panduit	DMV2-63B-3K	E78522	EL-29663
Quick connect terminal 4.8x0.8mm insulated PVC	22 - 18	0.5 - 1.0	Panduit	DMV1-48B-3K	E78522	EL-29664
Quick connect terminal 4.8x0.8mm insulated PVC	16 - 14	1.5 - 2.5	Panduit	DMV2-48B-3K	E78522	EL-29665
Terminal ring M5	20 - 18	0.5 - 1.0	BM	BM92115	Kain UL	EL-29654
Terminal ring M5	18 - 14	1.0 - 2.5	BM	BM92215	Kain UL	EL-29655
Terminal ring M4	20 - 18	0.5 - 1.0	BM	BM92114	Kain UL	EL-29656
Terminal ring M4	18 - 14	1.0 - 2.5	BM	BM92214	Kain UL	EL-29657
Quick connect terminal 6.3x0.8mm	22 - 18	0.3 - 0.9	Tycos	0-0041772-1	E66717	EL-11513
Quick connect terminal 6.3x0.8mm	17 - 13	1.0 - 2.5	Tycos	2-160256-2	E66717	EL-11808
Quick connect terminal 4.8x0.8mm	20 - 15	0.5 - 1.5	Tycos	5-160430-7	E66717	EL-29648
Quick connect terminal 4.8x0.8mm	17 - 13	1.0 - 2.5	Tycos	5-160429-2	E66717	EL-29649
Wire black	14		Desca AG	1249.590	UL 3266	EL-29669
Wire brown	14		Desca AG	1249.598	UL 3266	EL-30004
Wire bright blue	14		Desca AG	1249.593	UL 3266	EL-30003
Wire yellow / green	14		Desca AG	1249.594	UL 3266	EL-30005
Wire black	16		Desca AG	1249.500	UL 3266	EL-30006
Wire brown	16		Desca AG	1249.508	UL 3266	EL-30008
Wire bright blue	16		Desca AG	1249.503	UL 3266	EL-30007
Wire yellow / green	16		Desca AG	1249.504	UL 3266	EL-30009
Wire black	18		Desca AG	1248.500	UL 3266	EL-29668
Wire brown	18		Desca AG	1248.508	UL 3266	EL-30011
Wire bright blue	18		Desca AG	1248.503	UL 3266	EL-30010
Wire yellow / green	18		Desca AG	1248.504	UL 3266	EL-30012

overview: Standard end terminal connections

Product samples with wire harness



5120 Inlet filter with flexible wires and quick connect terminals, fully insulated

General Product Information



KD power entry module with wire harness and custom specific end terminals

Other product types of the large SCHURTER catalog offering will be included in the wire harness service in the near future.

Further details

At the start of the project, initial sample are provided by the manufacture to confirm the quality of the components and the interconnections. The serial production can start as soon as the customer release of the initial samples and the drawings is ready.



6600

Samples with wire harness



EC11



KFC

Further details about SCHURTER's wire harness options can be found on the SCHURTER website inquiry form for wire harness.

PULLOUT PREVENTION ON PLUGGABLE POWER SUPPLIES

To avoid the danger of accidentally unplugging a power cable from the device, several various types of pullout preventers are offered.

V-Lock locking system for the IEC-appliance couplers



The V-Lock locking system can be used for 10 A and 16 A power inlets and connectors according to IEC 60320. This system works in such a way that there is a pin in the socket, interlocking with a notch in the plug and thus prevents an unintentional pullout of the power cable.

The locking is released by pressing on the releasing lever. This lever is easily detected by its bright yellow colour and thus distinguishes this system from existing power cable connections.



V-Lock pullout prevention system prevents accidentally pulling out power cables in a simple manner

Plug connection with retaining clip

Another type of pullout prevention on pluggable power supplies are retaining clips, which are mounted to the device plug and are pressed over the cord connector. Regardless of device plug type and the multitude of electrical sockets shapes, the correct selection of retaining clip must be made. This retaining clip system ensures that the plug is correct, i.e. adequately deep, inserted to avoid the danger of accidentally unplugging a power cable from the device.

IP protection to the device including power supply protection

A special sealing kit increases the IP protection to the device including the protection of the plug connection. This additional safeguard assures a certain protection against the unwanted entry of moisture and dust when working with power cables that are plugged in. The power supply seal is produced with an inlet gasket around the plug pin. When plugged into a cable socket, the seal prevents liquids and dust on the plug pins from reaching live parts, as well as from ending up in the socket.

The device plug with inlet gasket is approved by IEC and UL. To be sure that the cord connector really is properly and completely plugged in, and to additionally protect the connection from accidentally being unplugged, device plugs should be equipped with a pullout preventer. Only in this way can an IP-protected connection be secured, regardless of operating conditions.



Plug connection with retaining clip and additional sealing kit

General Product Information

POWER ENTRY MODULES WITH FILTER

Same requirements are valid for filters as for RF suppression chokes.

INDUSTRIAL MAINS FILTERS

Frequency range 0.01 MHz ... 1000 MHz

General information

Electromagnetic compatibility (EMC) is the capability of electrical equipment (installations, devices, assemblies) to operate effectively in its electromagnetic environment (Immunity), without in turn irresponsibly affecting this environment (Emission).

Mains filters of various types are used for the protection of electronic circuits, components and equipment against transients or similar interference, on the mains power supply. A suitable filter can be selected from the existing product range for each equipment type in accordance with electromagnetic conditions of its environment.

Mains interference can be classified into four categories:

- A) Fluctuations in the industrial mains supply (magnetic voltage stabilizer)
- B) Harmonic wave interference in the frequency range 100 Hz ... 2 kHz (filter type selective harmonic)
- C) Transient interference signals in the frequency range up to 300 MHz (filter type low-pass)
- D) Sinusoidal interference signals in the frequency range up to 1 GHz (filter type broad band, low-pass)

In practice, however, interference is mainly found in the last three categories B, C and D. Superimposed on the high-voltage mains supply, such interference can affect the performance of electronic circuits, or even cause them damage. An optimally-designed mains filter can perform a double function:

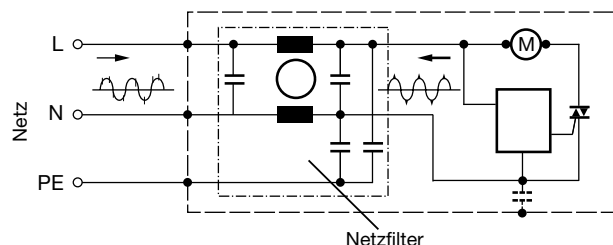

Function 1

The filter protects an electronic control circuit from voltage spikes in the mains supply, which may be generated, for example, by electro-mechanical switches and relays.

Function 2

The same filter also acts simultaneously in the opposite direction. The

HF interference generated in the unit by thyristor control is attenuated such that the boundary values Class B, (EN 55011/55022) are maintained.

Filters are usually made up of capacitors and inductance coils. Components such as leakage resistors, surge dissipators and VHF chokes can also be integrated into the filter. Broad band filters which meet the highest requirements are often composed of 2 or 3 single stages put together to make one filter unit:

Leakage current according to IEC 60335-1

The leakage current of a device is mainly determined by the capacity value of the Y-capacitor.

According to international standards (IEC 60335-1) the following regulations with respect to leakage current can be assumed:

Type of appliance	Protection class	I_L max. [mA]	U[V]	f[Hz]
Portable appliances	I	0.75	250	50
Stationary motor appliances *	I	3.5	250	50
Stationary heating appliances	I	0.75/kW (max. 5.0)	250	50
Appliances	II	0.25	250	50
Appliances	I, 0I, III	0.5	250	50

* Stationary appliances fixed or weighing in excess of 18 kg (without carrying handle).

For other applications:

Ref.	Laboratory	Medical	IT	Test equipment
UL	0.5 mA (UL 1262)	0.1 mA (UL 544)	3.5 mA (UL 1950)	5.0 mA (UL 1244)
IEC	–	0.1 mA (IEC 60601-1)	3.5 mA (IEC 60950)	3.5 mA (IEC 61010-1)

Rated voltage UR (U_{max})

The rated voltage UR is the maximum RMS alternating line to line voltage (U_{max}) which may be applied continuously to the terminals of the filter. The rated voltage is the nominal voltage including 10% tolerances.

Example:

Filter with $U_R = 440$ VAC is made for a power system with nominal voltage 400 VAC +10%.

For standard three phase filters the voltage between phase and earth is intended $U_R/\sqrt{3}$ (example 440/250 VAC).

Filters made for IT power systems withstand a voltage between phase and earth equal to U_R .

SCHURTER filters for IT systems have code ending with „I“: ex. FMAC-0932-2512I.

The line frequency f_N (50/60 Hz) may be exceeded under certain conditions. We recommend the users to consult in any case our technical department. DC power operation is possible in most cases.

General Product Information

Power distribution system

There are three main types of power distribution systems according to IEC 60950 (1.2.12): TN, TT, IT.

The TN POWER SYSTEM is a power distribution system having one point directly earthed, the exposed conductive parts of the installation being connected to that point by protective earth conductors. Three types of TN POWER SYSTEMS are recognized according to the arrangement of neutral and protective earth conductors: TN-S, TN-C-S, TN-C.

Example of a TN-C-S system

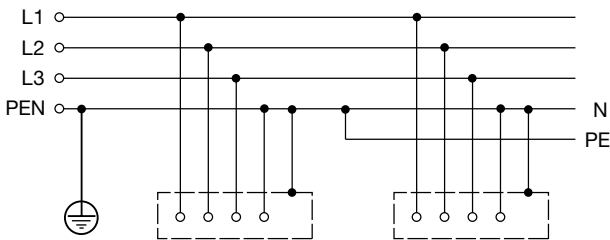

TN-C-S is in a system which neutral and protective functions are combined in a single conductors in a part of the system.

Example of a TT system

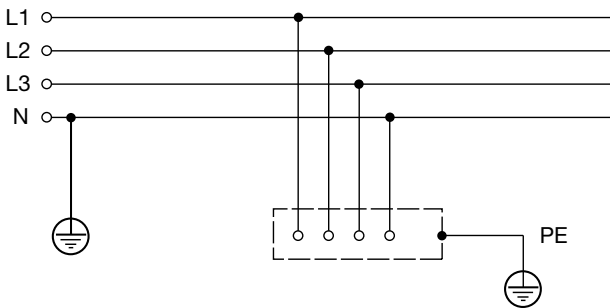

A TT POWER SYSTEM is a power distribution system having one point directly earthed, the exposed conductive parts of the installation being connected to earth electrodes electrically independent of the earth electrodes of the power system.

Example of a IT system

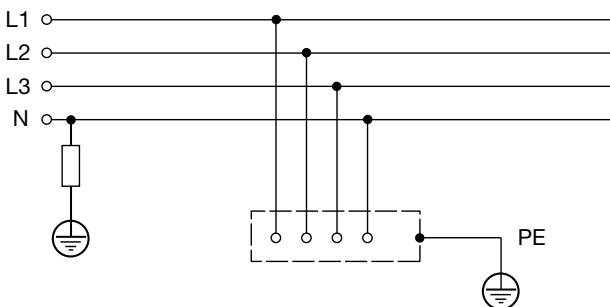

The IT POWER SYSTEM is a power distribution system having no direct connection to earth, the exposed conductive parts of the electrical installation being earthed. In this case the voltage between phase and earth can reach the line to line voltage.

Nominal Current I_N

The technical data gives the max continuous supply current in function of the ambient temperature I_N / a . The SCHURTER range generally differentiates between two types of filters:

- High-current filter: a at $I_N = 40^\circ\text{C}$
 $a_{\text{max}} = 100^\circ\text{C}$
- All other filters: a at $I_N = 40^\circ\text{C}$
 $a_{\text{max}} = 85^\circ\text{C}$

The permissible working current at higher ambient temperatures can be read from the following graph.

Permissible working current as a function of ambient temperature

Up to the approved nominal ambient temperature a the filter can be operated continuously at its nominal current. Above this temperature the square of the nominal current drops off linearly and reaches its zero point at T_{max} (85 or 100 °C).

Derating curve (approx.)

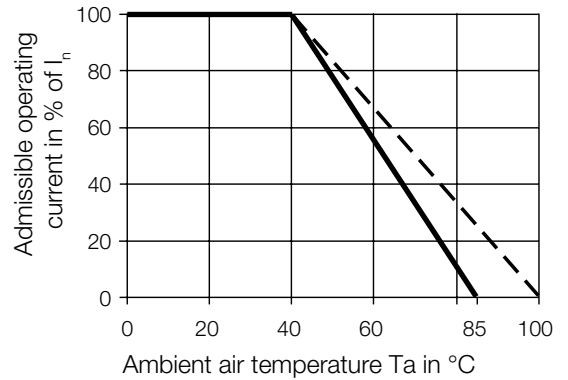

Formula:

$$I = I_n \sqrt{\frac{T_{\text{max}} - T_a}{T_{\text{max}} - T_n}}$$

- I = admissible operating current at elevated ambient air temperature
- I_n = rated current
- T_{max} = max. allowable ambient air temperature T_a (85 °C)
- T_a = ambient air temperature
- T_n = allowable ambient air temperature at rated current (40 °C)

Leakage current

(see also chapter RF suppression capacitors: General information)
1-Phase measuring techniques

Measurement method

General Product Information

Measurement of the leakage current (simplified).

The leakage current is measured from every pole of the network:
 - to all accessible metal parts
 - to metal parts of protection class II equipment which is separated only by the base material from parts under voltage.

The test is made with AC at 250 V / 50 Hz.
 Measurements are made in both switch positions (see diagram).

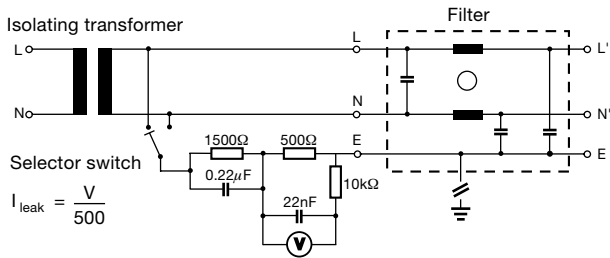

TT or TN Power System according to IEC 60950 - 5.2.3 - Annex D

Protection class I

Devices are fitted with a special grounding conductor to provide protection against electrical shocks (L,N,PE wire cable). SCHURTER filters correspond to protection class I.

Insertion loss acc. CISPR 17 (common- and differential mode)

Asymmetrical measurement

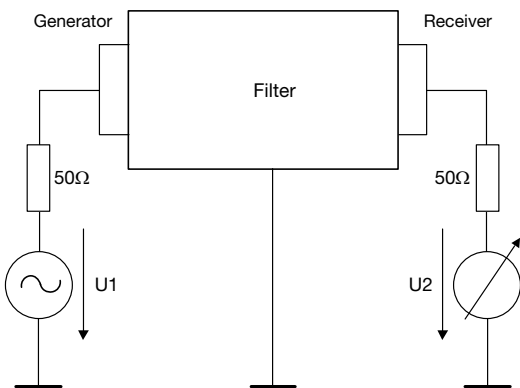

In common mode measurements, the line and neutral conductors are measured with respect to earth.
 Line (L) and neutral (N) are measured to earth (E).

Symmetrical measurement

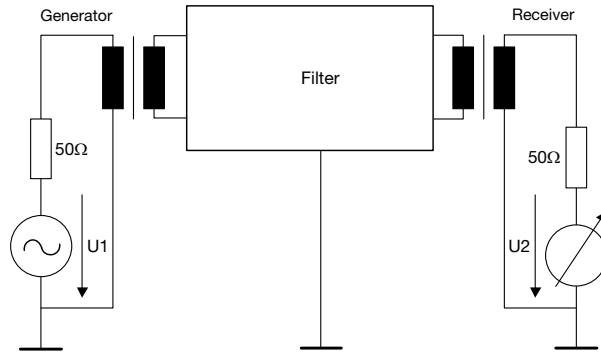

In differential mode measurements, the insertion transmission loss is measured between line and neutral through a balancing transformer; the earth wire is not used.
 4-pole network with integrated balancing transformer for the measurement of insertion transmission loss in the symmetric case.

Measurement method

The insertion loss D is defined as that loss which results when a four-pole network is inserted into an existing layout, having a surge impedance Z, assuming that the LHS and the RHS terminal impedances of the four-pole network are equal in magnitude and real, the insertion transmission loss and the overall loss are the same.

The insertion transmission loss, in decibels, can be obtained as follows:

$$D_{dB} = \frac{20 \log (U_1)}{2 U_2}$$

Insertion loss "alternate test method"

Asymmetrical measurement

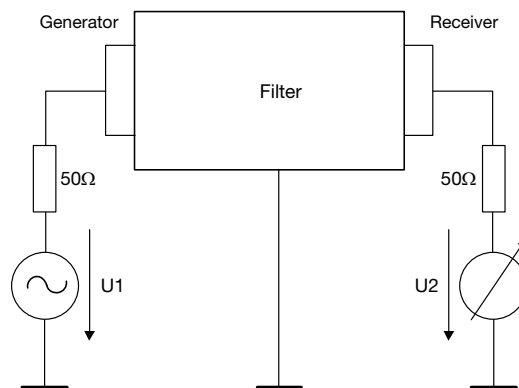

Symmetrical measurement

General Product Information

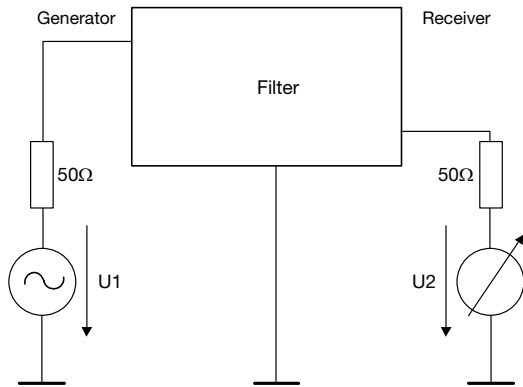

The alternate test method allows the measurement in the GHz frequency range whereas the CISPR 17 method does not cover frequencies above 30MHz. The insertion loss is measured in a throughput method (common mode) and a cross coupled method (differential mode). The differential mode measurement of the alternate test method is not directly comparable to the conventional measurement acc. CISPR 17.

Voltage tests on noise suppression filters complying to EN 133200 II

IEC 60939-2

Nominal voltage connections	Between	Inner and outer insulation	
		C* ≤ 1 μF	C* > 1 μF
150 ≤ U _R ≤ 250 VAC	4.3 U _R VDC	1500 VAC or 2250 VDC	4.3 U _R VDC
250 ≤ U _R ≤ 500 VAC	4.3 U _R VDC	2 kVAC or 3 kVDC	4.3 U _R VDC
500 ≤ U _R ≤ 760 VAC	4.3 U _R VDC	3 kVAC or 4 kVDC	4.3 U _R VDC

* C is the capacity measured between the connection block to which the high voltage is connected for test.

UL 1283

(Appliance filters)

Nominal voltage	Between connection	Between connection and case
U _R ≤ 250 VAC	1250 VAC or 1768 VDC	1500 VAC or 2121 VDC

In compliance to the known standards of the IEC, EN, VDE and UL, the filters are tested as follows. In principle, these tests correspond to those of the RF suppression capacitors.

Test duration

- 2 sec for production test
- 60 sec for types test

The SCHURTER final production test has a duration of 2 sec. This test may not be repeated more than one time (i.e. incoming inspection at the customer). Any filter that has been under test for 60 sec can not be commercially used (reduced life cycle).

Application classes (IEC 60068-1)

The aim of this standard is to create a basis for classification of telecommunication engineering electrical components according to application classes which correspond to their climatic and mechanical suitability.

Example:

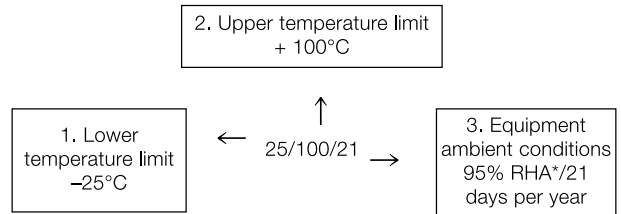

* relative humidity

MTBF

The high reliability of the filters can be excelled from MTBF (meantime between failures). These values are according MIL-HB-217-F class G_B at an ambient temperature 40°C at rated voltage and current.

3-stage filter

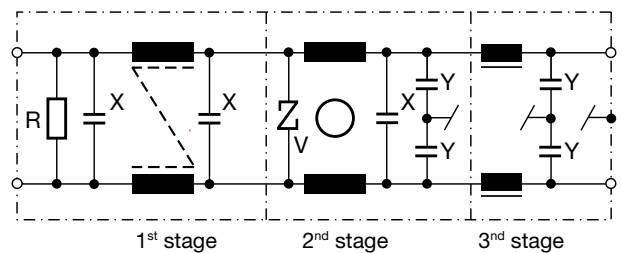

1st stage

A differential mode acting filter with high energy absorption. Discharging resistors are normally used for C_x capacitors > 100 nF. The capacitors are tested and approved as so-called class X noise suppression capacitors. The 1st stage serves as di/dt limitation.

2nd stage

A common mode acting filter with a high, broad band attenuation ratio. A ZNR varistor surge serves as the overvoltage suppression component. The earthed capacitors are tested and approved as so-called class Y noise suppression capacitors.

3rd stage

Common mode as well as differential mode acting filter in the HF range up to 300 MHz. Feedthrough capacitors make high attenuation values possible up to the gigahertz range. These capacitors are also class Y type. SCHURTER uses only approved noise suppression ca-

General Product Information

capitors according to EN 132400.

Filter assemblies

Three types of mains noise suppression filter assemblies are used in practice:

Collective suppressor

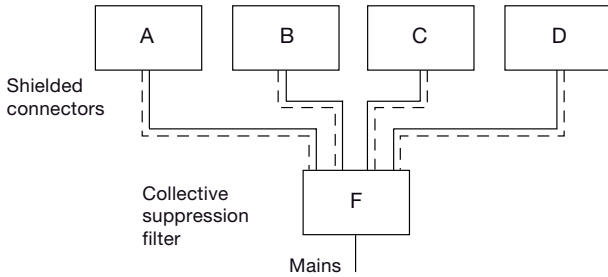

The collective suppressor principle results in one filter per plant. This has to cope with the entire power input. In addition, all of the connecting cables have to be shielded. Furthermore interference generated by «A» device can reach other devices for instance «B» or «C» through the connecting cables. The following example promises to be a more economical solution. In many cases, the single suppressor principle is the most economical solution.

Single suppressors

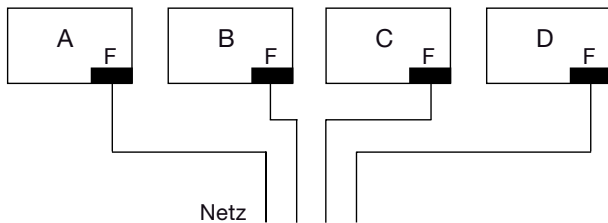

Combined single and collective suppressor

From the technical point of view, only the combined application of both suppression techniques can result in a significant improvement.

Interference propagation

In the field of interference and RF suppression, the most significant means of transmission is the direct electrical connection, i.e. the connecting wiring. The radiation coupling is also important from the electromagnetic compatibility (EMC) point of view; it cannot, however, be dealt with here.

Interference propagation

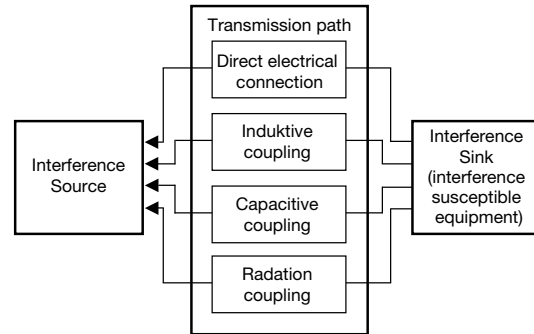

Propagation and Coupling Paths

The capacitive and inductive coupling effects occur inside the case. These could be:

- Capacitive coupling through the coupling capacity of a mains transformer.
- Inductive coupling through control system wiring in parallel.

The introduction briefly mentioned the possibility of the mains filter operating with a double function. Depending on the main area of application, these filters are designated as either RF SUPPRESSION FILTERS or INTERFERENCE SUPPRESSION FILTERS.

The one filter may, therefore, appear under two references in the documentation. A filter is also classified by its mechanical design as well as its electrical data.

RF SUPPRESSION FILTERS impede the propagation of RF interference, generated by an electronic or electrical device into the mains. They also ensure an interference-free radio reception in the immediate vicinity.

INTERFERENCE SUPPRESSION FILTERS prevent mains interference from affecting electronic equipment. They enable an interference-free operation even in the case of a power supply badly affected by mains interference.

It is common to operate the mains filter in both directions in the one piece of equipment, allowing it to fulfil its double function as both interference and RF suppression filters as specified.

Common- and differential mode interference

Filter engineering differentiates between common and differential mode interference originating from supply lines.

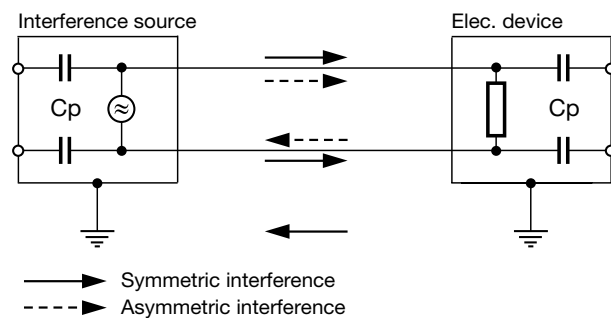

In the case of a non-earthed interference source, interference at first only propagates along the connecting lines. Like the mains AC current, the parasitic current flows to the user on one lead, and returns

General Product Information

to the interference source on the other. Both these currents are in differential mode. This type of interference is therefore referred to as differential mode interference.

Due to the mechanical configuration and its parasitic capacitance, parasitic currents are also generated in the earthing circuit. This parasitic current flows on both connecting leads to the user and over an earthed lead back to the interference source. Both currents on the connecting lead are in common mode. This type of interference is therefore referred to as common mode interference.

Filter classification

For easy reading of the catalogue data, SCHURTER uses the following simplified filter classification:

Differential Mode and Common Mode Attenuation

Attenuation value			
Standard	Medium	High	Excellent
20-50 dB	40-70 dB	60-80 dB	70-95 dB

Leakage Current Classification

Operating leakage current			
Medical	Standard	Industrial	Other
<0.1 mA	<0.5 mA	<5 mA	>5 mA

Medical filter

SCHURTER medical filters comply with UL544 and IEC 60601-1 standard specifications and are available in two versions, which differ in terms of their leakage current values.

Medical filter (M5)

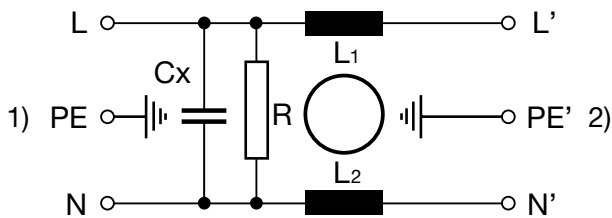

1) Line
2) Load

Medical filter (M80)

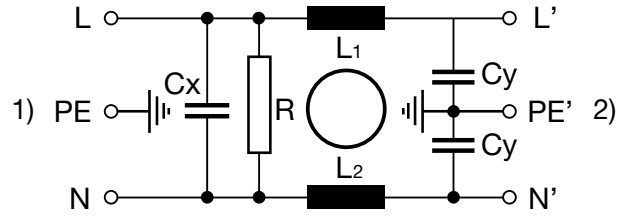

1) Line
2) Load

Standard medical filters for direct person contact supplied by SCHURTER have a leakage current value of <math><5 \mu\text{A}</math> (M5). This can only be achieved without C_y . Here, a common mode fault current against earth is not attenuated and the filter acts only on differential mode fault currents. In addition, an inlet in protection class II can be used here, as no earth connection exists. However, if an earth connection is desired, Type (M80) can be used for indirect person contact; this has a leakage current of <math><80 \mu\text{A}</math> which is below the required limit value of 0.1 mA. Type (M80) is manufactured to special order.

Bleed resistor

Medical filters and filters with a X-capacitor >100 nF have a bleed resistor so that no inadmissible rest voltage occurs at the touchable pins of the inlet.

Test voltages

Chokes for	Between connections	Inner and outer insulation
AC	$4.3 U_R \text{ VDC}$	$2 U_R + 1500 \text{ VAC}$, but at least 2000 VAC
DC	$3 U_R \text{ VDC}$	$2 U_R + 1500 \text{ VDC}$

Temperature rise at nominal current: $T = 60^\circ\text{C}$

Short-circuit strength:

EN and VDE: not applicable

SEV : $25 \times I_N$ (2 half-waves)

Current compensated chokes in interference suppression filters

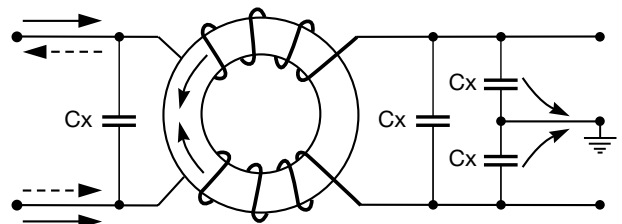

-----> Symmetric interference
-----> Asymmetric interference

The main type of choke used in suppression filter engineering is the

General Product Information

current compensated choke. This mainly damps the common mode interference. The differential mode parasitic current, or rather the magnetic flux they produce in the core, is compensated by means of a special type of winding. The relatively small attenuation of the differential mode parasitic currents can be balanced through the large, symmetrically connected capacitance C_x between the lines. Only the leakage inductance L_s of the choke is then of any importance.

$$L_{\text{leakage}} \approx \frac{L_{\text{nominal}}}{50} \text{ to } \frac{L_{\text{nominal}}}{100}$$

The high nominal inductance L_N active for common mode parasitic currents allows the insertion of small, earthed capacitances C_Y in a filter circuit. These capacitances are regulated by international standards for leakage currents.

RF suppression capacitors: General information

All SCHURTER filters are fitted with class X or Y RF suppression capacitors in accordance with international standards (IEC, EN). These are mainly self-healing metallized paper or polyester types, tested against the standards of major countries around the world and approved as noise suppression capacitors. Class X capacitors are capacitors with unlimited capacity for those applications in which a failure caused by a short circuit cannot result in a dangerous electrical shock. Class Y capacitors are capacitors intended for an operating voltage $U_{\text{eff}} = 250$ V with increased electrical and mechanical safety and limited capacitance.

RF Suppression capacitor complying with IEC 60384-14

All SCHURTER filters are equipped with components which have been tested and approved as R_F suppression capacitors. The most important test data for R_F suppression capacitors are: Capacitance C_x , $C_y \pm 20\%$ for $f_M = 1$ kHz

Insulation resistance R_{is} between the capacitor terminals:
for $C > 0.33 \mu\text{F}$: $R_{is} \times C > 2000$ s (time constant)

EMC requirements in Europe

Household, Luminaries and Telecommunication

Residential, commercial and light industrial

Emission

- IEC 61000-6-3 (EN 50081-1)
- EN 55022 ITE Information technology equipment
- EN 55014 Household Applications and Tools
- Harmonic (IEC 61000-3-2)
- Voltage fluctuations (IEC 61000-3-3)

Immunity

- IEC 61000-6-1 (EN 50082-1)
- IEC 61000-4-2 ESD
- IEC 61000-4-3 HF-Field
- IEC 61000-4-4 Burst
- IEC 61000-4-5 Surge

Class Industrial

(ISM) Industrial, Scientific and Medical

Emission

- IEC 61000-6-4(EN 50081-2)
- EN 55011
- Harmonics (IEC 61000-3-2)
- Voltage fluctuation (IEC 61000-3-3)

Immunity

- IEC 61000-6-2 (EN 50082-2)
- IEC 61000-4-2 ESD
- IEC 61000-4-3 Inducted HF-Field (enclosure)
- IEC 61000-4-6 Inducted HF-Field (lines)
- IEC 61000-4-4 Burst
- IEC 61000-4-5 Surge
- IEC 61000-4-8 NF Magnetic Field (only for magnetic devices)

for $C > 0.33 \mu\text{F}$: $R_{is} > 6000$ MOhm

Major voltage test and standards for C_x and C_y capacitors

Country	Standard	C	Rigidity	Pulse Test 1.2/50 μs
Europe	EN 132400	X1	4.3 UR VAC	4.0 kV
		X2	4.3 UR VAC	2.5 kV
		Y1	4.0 kVAC	8.0 kV
	IEC 60950 (Equipment Standard)	Y2	2.5 kVAC	5.0 kV
		X1	2700 V_{DC} , 60s	4.0 kV
		X2	2121 V_{DC} , 60s	2.5 kV
USA	UL 1414		2121 V_{DC} , 60s	50 Pulse, 10 kV, 1000 W
	UL 1283		2121 VDC, 60s 2545 VDC, 1s	-
Switzerland	SEV 1055	x	4.3 UR VAC	3.0 kV
		y	2(100 + 2 UR) min. 2250 VAC	5.0 kV

X2Y® filter

X2Y® filter combines the X and Y capacitors into a component that is in contact with the filter enclosure over a broad surface. The leads connecting the capacitors are thereby eliminated and parasitic impedances are reduced to a minimum. This results in broadband suppression into high frequency ranges.

EMC REQUIREMENTS IN EUROPE

Electrical safety regulations

The most important safety standards for equipment/installations are listed in the following:

IEC 60950 Safety of information technology equipment including

electrical business equipment

IEC 60335 Safety of household and similar electrical appliances

IEC 61010-1 Safety requirements for electronic measuring apparatus

IEC 60601 Safety requirements for electro-medical equipment

UL 1950 Safety requirements for information technology equipment

UL 544 Electric medical and dental equipment

General Product Information

Interference emissions

There are basically 2 types of emitted disturbances: conducted and radiated. Line interferences are high frequency noise signals which are superimposed on the useful signals on input and output lines. Interference signals can be of common- or differential mode type. The significance of line interference is reduced dramatically above a frequency of 30 MHz. From here radiated interference increases greatly. On the following pages we will nevertheless deal with conducted interference only.

Measuring technique CISPR 3

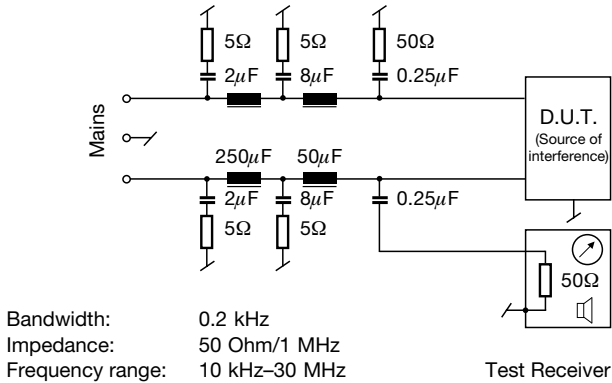

Radio frequency interference boundary values

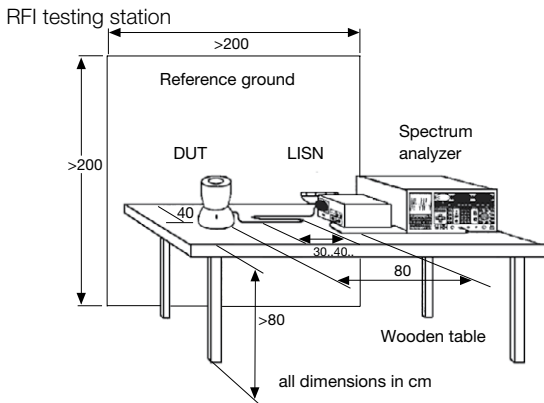

EN 55011: Boundary values and measuring systems for RF suppression for industrial, scientific and medical high frequency equipment (ISM), 1991 (see also CISPR 11 or VDE 0871)

Boundary values complying with EN 55011

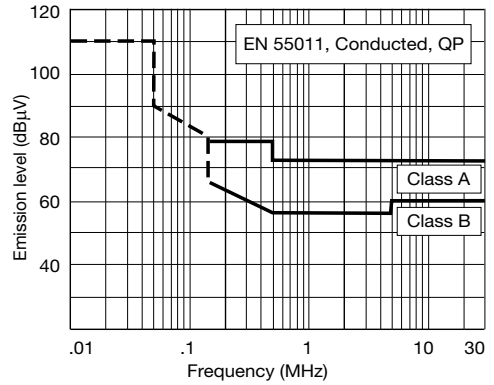

Quasipeak (QP) and Average (AV) are two limits, neither of which must be exceeded and which are measured by two different test receivers. The test arrangement remains the same. These boundary values replace the boundary values given by the old standards for broadband and narrowband noise generators.

Boundary values are divided into class A and B.

Into class A fall those devices which should not be operated in residential buildings and should not be connected to power supplies which also supply these areas. Class A boundary values shall not be exceeded.

Into class B fall devices for which above restrictions do not apply. Class B boundary values shall not be exceeded.

EN 55022: Boundary values and measuring systems for RF suppression for information technology installations (Telecommunications) 1987 (see also CISPR 22 or VDE 0878).

Boundary values complying with EN 55022

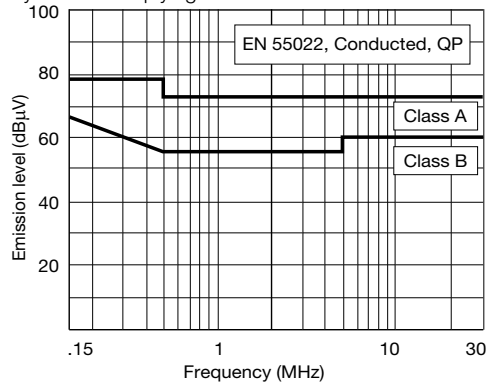

Into class A fall all units which should be used in a commercial environment and should be used with a safety distance of 30 m to other units.

Into class B fall all units which have no restrictions on their use.

EN 55013: Boundary value and measuring techniques for RF suppression characteristics of radio receivers and connected applications.

EN 55014: Boundary values and measuring systems for RF suppression for electrical household appliances, handheld electrical tools and similar electrical products, 1993 (see also CISPR 14).

EN 55015: Boundary values and measuring systems for RF suppression for fluorescent lamps and lighting, 1993 (see also CISPR 13).

Harmonics

(EN 61000-3-2, IEC 61000-3-2)

General Product Information

Current harmonics represent a distortion of the normal sine wave provided by the utility. When a product such as an SCR switched load or a switching power supply distorts the current, harmonics at multiples of the power line frequency are generated. Two significant consequences arise as a result of harmonic generation. First, because of finite impedances of power lines, voltage variations are generated that other equipment on the line must tolerate. Second, when generated in a three-phase system, harmonics may cause overheating of neutral lines.

Power line harmonics are generated when a load draws a non linear current from a sinusoidal voltage. The harmonic component is an element of a Fourier series which can be used to define any periodic waveshape. The harmonic order or number is the integral number defined by the ratio of the frequency of the harmonic to the fundamental frequency (e.g., 150 Hz is the third harmonic of 50 Hz; $n = 150/50$).

After multiple postponement finishes at 1.1. 2001 the transition-period for the EN 61000-3-2, frequently called "PFC-Norm". It applies to all electrical and electronic devices with input current up to max. 16 A per phase, which are designed to connect to the general lowvoltage mains. Limits are set only for 220/380 V, 230/400 V and 240/415 V at 50 Hz.

This standard distinguishes four classes of equipment.

- A Symmetric three phase equipment and all other equipment not in other classes
- B Portable tools
- C Lighting equipment
- D Equipment having special waveshape (see EN 61000-3-2, paragraph 4 picture 1)

A harmonics test to conform to the standards must include an analysis of the incoming current up to the 40th harmonic (for $f_N = 50$ Hz, $f_H = 2$ kHz).

The IEC 61642 "Industrial a.c. networks affected by harmonics- application of filters and shunt capacitors" give guidance for the use of passive a.c. harmonic filters and shunt capacitors for the limitation of harmonics and power factor correction intended to be used in industrial applications, at low and high voltages.

Voltage fluctuations (Flicker)

(EN61000-3-3, IEC 61000-3-3, IEC 61000-3-5)

The appearance of flicker effects and voltage fluctuations on the mains supply is caused by varying loads connected to the mains. The most critical are the effects of voltage fluctuations on equipment such as lights and illumination. Here the light output and thereby the intensity is an exponential function of the supplied voltage. This fluctuation in light intensity is called flicker. Many people experience dizziness and headaches as a result.

There are various limit values depending on the type of voltage fluctuation (square, sinusoidal and mixed or erratic voltage fluctuation).

Flickers are measured by so-called flicker meters (arranged in compliance with EN 60808).

Guideline for the selection of ESD test levels

Class	Relative ambient humidity as low as [%]	Antistatic material (floor)	Synthetic material (floor)	Level air discharge (kV)	Level contact discharge (kV)
Class 1	35	x		2.00	2.00
Class 2	10	x		4.00	4.00
Class 3	50		x	8.00	6.00

Immunity

ESD (Electrostatic Discharge)

(EN 61000-4-2, IEC 61000-4-2)

One of the main interference sources, along with switching through radio interference, is electrostatic discharge from people and equipment.

Burst

(EN 61000-4-4, IEC 61000-4-4)

One of the most common and most dangerous sources of interference are transient disturbances such as those originating from switching transients (interruption of inductive loads, relay contact bounce, etc.). The burst test measures the resistance of the device to repetitive fast transients.

Surge

(EN 61000-4-5, IEC 61000-4-5)

This test procedure measures the behaviour of a device when subjected to high-energy pulses. Sources of such pulses are switching events due to lightning strikes, short-circuits, or switching cycles which vary in time and place. Surge test on SCHURTER filters are according to EN 133200.

Specification of the burst test impulse

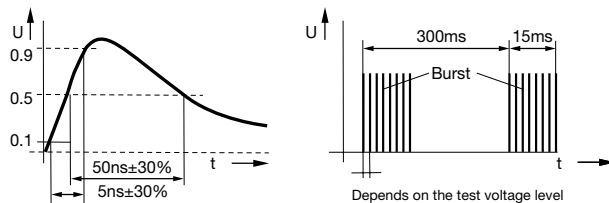

Surge voltage form in open circuit

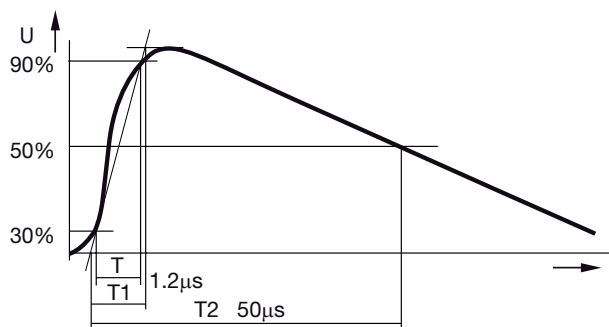

General Product Information

Guideline for the selection of ESD test levels

Class 4	10	x	15.00	8.00
---------	----	---	-------	------

Recommended test levels for Fast Transient/Burst (acc. IEC 61000-4-4)

Test levels	The installation is characterized by following attributes	Voltage peak: [kV]		Repetition rate [kHz]
		Power supply	Signal ports	
Level 1 Well-protected environment	<ul style="list-style-type: none"> - Suppression of all EFT/B* in the switched power supply circuits - Separation between power supply lines and control and measurement circuits - Shielded power supply cables with the screens earthed at both ends 	0.50	0.25	5.0
Level 2 Protected environment	<ul style="list-style-type: none"> - Partial suppression of EFT/B* in the power supply and control circuits - Separation of all the circuits from other circuits associated with environments of higher severity levels - Physical separation of unshielded power supply and control cable from signal and communication cables 	1.00	0.50	5.0
Level 3 Typical industrial environment	<ul style="list-style-type: none"> - No suppression of EFT/B* in the power supply and control circuits - Poor separation of the industrial circuits from other circuits - Dedicated cables for power supply, control, signal and communication lines - Poor separation between power supply, control, signal and communication cables 	2.00	1.00	5.0
Level 4 Severe industrial environment	<ul style="list-style-type: none"> - No Suppression of EFT/B* in the power supply and control and power circuits - No separation between power supply, control, signal and communication cables - Use of multicore cables in common for control and signal lines 	4.00	2.00	2.5

*EFT/B: Electrical Fast Transient/Burst

Installation classification for Surge Immunity test (acc. IEC 61000-4-5)

Class	Environment definition	Voltage peak [kV]	
		L N [2kΩ]	L/N PE [12Ω]
Class 0 well-protected environment	<ul style="list-style-type: none"> - All cables with overvoltage protection - Well-designed earthing system - Surge voltage may not exceed 25 V 	-	-
Class 1 Partly protected environment	<ul style="list-style-type: none"> - All cables with overvoltage protection, well interconnected earth line network - Power supply completely separated from the other equipment - Surge voltage may not exceed 500 V 	-	0.50
Class 2	<ul style="list-style-type: none"> - Separate earth line to earthing system - The power supply is separated from other circuits - Non-protected circuits are in the installation, but well separated and in restricted numbers - Surge voltage may not exceed 1000 V 	0.50	1.00
Class 3	<ul style="list-style-type: none"> - The installation is earthed to the common earthing system - Protected electronic equipment and less sensitive electric equipment on the same power supply network - Unsuppressed inductive loads are in the installation 	1.00	2.00
Class 4	<ul style="list-style-type: none"> - The installation is connected to the earthing system for the power installation - Current in the kA range due to earth faults - The power supply network can be the same for both the electronic and the electrical equipment - Surge voltages may not exceed 2000 V 	2.00	4.00
Class 5	<ul style="list-style-type: none"> - Electrical environment for electronic equipment connected to telecommunication cables - The interference voltages can be extremely high - All cables and lines are provided with overvoltage protection 	dep. on the local power supply network	dep. on the local power supply network