

Odporové trimre cermetové, viacotáčkové

Séria 64

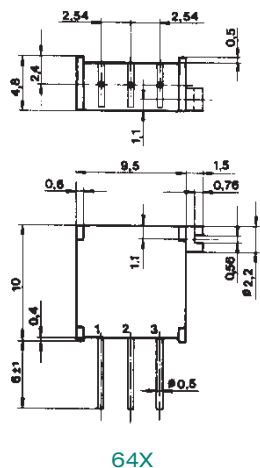
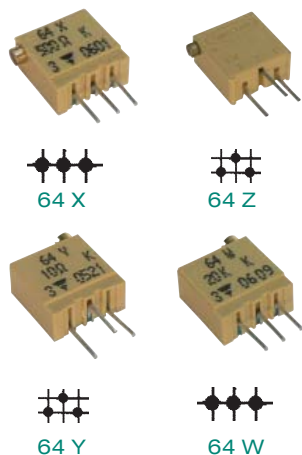

Technické parametre	64
Počet otáčok - mechanické	23±5
Počet otáčok - elektrické	21±2
Výkonové zaťaženie pri 70°C	0,5W
Dovolené pracovné napätie	250V
Rozsah hodnôt	10R...2M0
Tolerancia	±10%
Teplotný koeficient	±100ppm/°C
Izolačné napätie	1000Vef
Teplotný rozsah	-55...+125°C
Balenie	50 ks
Ako objednávať	64 X 100 R

Hodnota	64 X	64 Y	64 Z	64 W
10R	o 57984	s 18022		o 18021
50R	o 57985	s 18024		o 18040
100R	o 30157	s 18025	o 57986	o 18041
200R	o 30158	s 18026	o 57987	o 18042
500R	s 30159	s 18027	o 20452	s 18043
1K	o 30160	s 18028	s 20453	s 18044
2K	o 30161	s 18029	s 20665	s 18045
5K	s 30162	s 18030	o 20454	s 18046
10K	s 30163	s 18031	s 20455	s 18047
20K	s 30164	s 18032	o 20456	s 18048
50K	o 30165	s 18033	s 20457	s 18049
100K	o 30166	s 18034	s 20458	s 18050
200K	o 30167	s 18035	o 20459	s 18051
500K	o 30168	s 18036	o 20460	s 18052

	1+	5+	25+	100+
64 X	0,751	0,703	0,645	0,608
64 Y	0,752	0,706	0,614	0,604
64 Z	0,761	0,713	0,650	0,611
64 W	0,743	0,695	0,635	0,595

Séria 43P

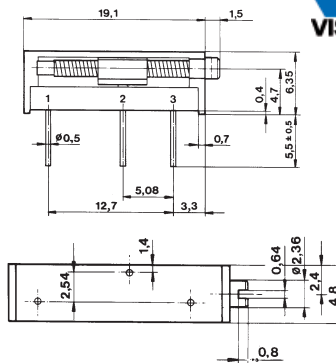
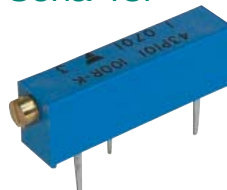

Technické parametre	43 P
Počet otáčok - mechanické	18±5
Počet otáčok - elektrické	15±1
Výkonové zaťaženie pri 70°C	0,5W
Dovolené pracovné napätie	250V
Rozsah hodnôt	10R...2M0
Tolerancia	±10%
Teplotný koeficient	100ppm/°C
Izolačné napätie	1000Vef
Teplotný rozsah	-55...+125°C
Balenie	25 ks
Ako objednávať	43 P 100 R

Hodnota	43 P	Hodnota	43 P	Hodnota	43 P
10R	s 19877	1K	s 19883	50K	s 19888
50R	s 19879	2K	s 19884	100K	s 19889
100R	s 19880	5K	s 19885	200K	s 19890
200R	s 19881	10K	s 19886	500K	s 19891
500R	s 19882	20K	s 19887	1M	s 19892

	1+	5+	25+	100+
43 P	0,560	0,523	0,478	0,450

Útlmové články VF (atenuátory)

Typ AT10PHF

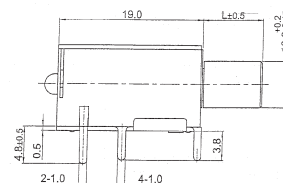

Typ AT10VYF

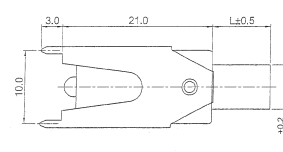
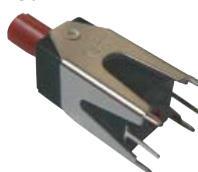

Technické parametre	AT10PHF	AT10VYF
Max. útlm	20dB	20dB
Impedancia	75 Ω	75 Ω
Max. frekvencia	800 MHz	800 MHz
Počet otáčok	bez dorazu	bez dorazu
Max. napätie	50V	50V
Výkonové zaťaženie	0,02W	0,02W
Priemer osky	9mm	9mm
Farba	červená	červená
Označenie výrobcu	AT10PHF-B-9SRB-3,5Y-20	AT10PVYF-B-9SRB-3,5Y-20
Ako objednávať	AT PHF	AT VYF

Typ	Obj.č.	1+	10+	50+
AT10PHF	s 52520	1,484	1,1818	1,0606
AT10VYF	s 52522	1,484	1,1818	1,0606